

THE REVIEW OF OPTOMETRY

2014 CONFERENCE PLANNER

A comprehensive guide to this year's optometric CE destinations.

Inside: Details for nearly 200 live continuing education events. Find out where to visit, what you'll learn and who will be lecturing at CE courses big and small, from coast to coast, all year long.

A supplement to

REVIEW
OF OPTOMETRY



How many other lenses can say they're more comfortable than ACUVUE® OASYS® Brand Contact Lenses?

NONE.

In published clinical studies and those registered on clinicaltrials.gov,
**ACUVUE® OASYS® Brand has never been beaten
for comfort by any leading monthly lens.***

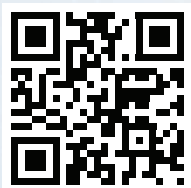

Visit acuvuepro.com
to learn more about
ACUVUE® OASYS® Brand Family.

*Based on review of published clinical studies and those registered on clinicaltrials.gov with comfort as an endpoint.

ACUVUE® Brand Contact Lenses are indicated for vision correction. As with any contact lens, eye problems, including corneal ulcers, can develop. Some wearers may experience mild irritation, itching or discomfort. Lenses should not be prescribed if patients have any eye infection, or experience eye discomfort, excessive tearing, vision changes, redness or other eye problems. Consult the package insert for complete information. Complete information is also available from VISTAKON® Division of Johnson & Johnson Vision Care, Inc., by calling 1-800-843-2020 or by visiting acuvueprofessional.com.

ACUVUE®, ACUVUE® OASYS®, HYDRACLEAR®, and VISTAKON® are trademarks of Johnson & Johnson Vision Care, Inc.

© Johnson & Johnson Vision Care, Inc. 2013 ACU-32200G September 2013

Hygroscopic,
hydrophilic,
tear-attracting
polymer

Silicone
hydrogel

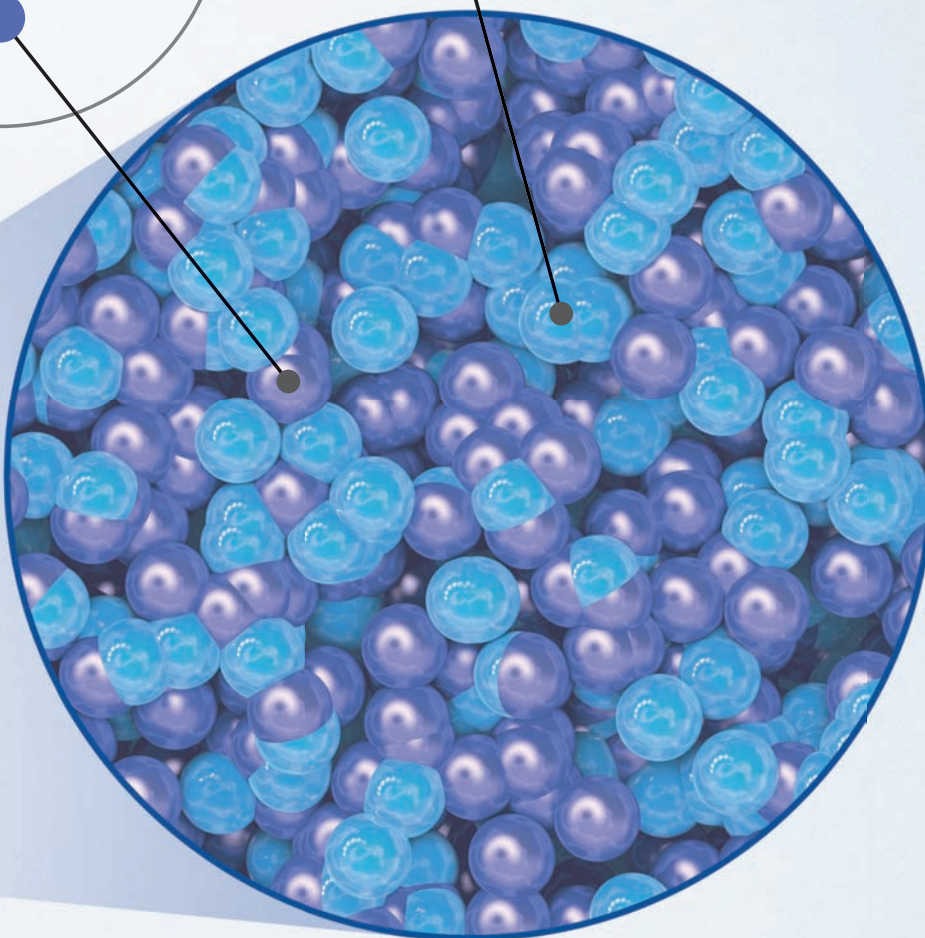

ACUVUE[®]

QASYS[®]

BRAND CONTACT LENSES

WITH HYDRACLEAR[®] PLUS

**Up To 15
CE Credits**
(COPE approval pending)

2014

NEW TECHNOLOGIES AND TREATMENTS IN VISION CARE

...*REVIEW* MEETINGS OF CLINICAL EXCELLENCE

SAVE THESE DATES:

SAN DIEGO, CA

May 2-4

ORLANDO, FL

June 19-22

MINNEAPOLIS, MN

July 17-20

TYSONS CORNER, VA
(Washington DC area)

September 12-14

 **REVIEW**[®]
OF OPTOMETRY

 **cope**[®]
*Approval pending

For more information visit www.revoptom.com

Welcome

The Pursuit of Education Elevates and Inspires Us All

As clinicians, our top priority is our patients. Continuing education is important in any profession, but for doctors it is especially critical because new ideas and technology are constantly evolving and changing the way we practice. CE empowers us and gives us the vital knowledge necessary not just to stay up-to-date, but also to improve



our patients' health and their quality of life.

Compared to other providers of health care, an optometrist's educational needs are unique. In recent years, expanded scope of practice laws have been enacted in a majority of states. These advances are much overdue, and the recognition invigorates us as a profession. Still, these new opportunities raise the bar on what is expected of us.

Continuing education is the bridge that can help us get there.

As ophthalmologists focus more on surgery, our primary eye care and clinical responsibilities are becoming greater. This inexorable trend offers yet another exciting opportunity for us to become the main eye care provider for our patients.

With this in mind, *Review of Optometry* is pleased to present its first Conference Planner, a comprehensive list of continuing education opportunities offered in 2014—from intimate one-day

meetings for local audiences to the big conferences spanning multiple days that draw national and international attendees. Looking over the nearly 200 events planned for 2014, one can't help but marvel at the effort and energy with which our profession's leaders have responded to the CE challenge. It is truly admirable and inspiring.

Jobson and Review of Optometry have a long history of offering optometric CE, including clinical articles in the magazine and as host of informative continuing education meetings where some of the brightest minds in eye care offer their insights on myriad clinical topics.

In 2014, *Review of Optometry* will continue to offer its "New Technologies and Treatments" meeting series, which will be held in numerous locations across the US (for details, visit www.revoptom.com/conferences). During these meetings, attendees learn about the latest therapeutics and technologies available to diagnose and treat ocular diseases.

We hope this 2014 Conference Planner will be a helpful resource as you plan your continuing education efforts for the coming year.

Sincerely,

Paul Karpecki, OD
Chief Clinical Editor

Table of Contents

5..... Welcome

10..... January

14..... February

18..... March

26..... April

32..... May

36..... June

42..... July

46..... August

48..... September

54..... October

58..... November

65..... December



19
Atlanta
SECO



38
Philadelphia
AOA



59
Denver
Academy

KEY TO EDUCATIONAL TOPICS

Lecture topics scheduled to be discussed at educational events are denoted by the appearance of the icons at right, based on information known at press time.

Conference agendas are subject to change. Contact meeting organizers for updated information.

- AL** Allergy
- AM** Amblyopia
- BV** Binocular Vision
- CM** Comanagement
- CL** Contact Lenses
- CD** Corneal/Conjunctival Disease
- CS** Corneal Surgery
- CT** Cataract Surgery

- DB** Diabetes
- DE** Dry Eye
- EL** Eyelid/Adnexal Disease
- GL** Glaucoma
- NO** Neuro-ophthalmic Disease
- NT** Nutrition & the Eye
- IN** Ocular Infections
- DS** Optical Dispensing

- PE** Pediatric Eye Care
- PH** Pharmacology
- PM** Practice Management
- RE** Retinal Disease
- RS** Refractive Surgery
- SD** Systemic Disease
- UV** Uveitis
- VT** Vision Therapy



and the Blue Light Hazard

Blue light plays a paradoxical role in health and vision. Not only is blue light essential for color perception, recent research has found that light in this band triggers critical physiological responses that include pupil constriction reflex and synchronization of the human biological clock. However, blue light may also be damaging to the eye, and the term “blue light hazard” has been coined to describe the danger this light presents to critical structures within the eye. Blue light can induce formation of damaging phototoxins, leading first to the death of critical retinal pigment epithelium (RPE) cells and then to photoreceptors. This damage is cumulative, and has been implicated in the development of retinal degenerative diseases such as age-related macular degeneration (AMD). The fact that blue light is both beneficial and harmful raises a critical question: Can we protect the eye from harmful blue light without simultaneously denying it the beneficial blue light? One way to accomplish this would be the creation of a lens that would selectively filter out the harmful wavelengths while transmitting the beneficial ones.

To determine if specific bands within the blue light spectrum

were responsible for blue light’s phototoxic effects, researchers from Essilor’s Paris R&D laboratories joined forces with scientists from the Paris Vision Institute - one of the most important research centers in Europe on eye diseases—to develop a unique illumination system that allowed cultured swine retinal cells to be exposed to narrow bands of light. Using this test system, it was discovered that RPE phototoxicity was concentrated in a relatively narrow band, separate from the wavelengths necessary for the beneficial physiological effects of blue light. This finding paved the way for **selective photofiltration**: the creation of lenses that reduce the level of exposure to the harmful portion of the blue light spectrum, ranging from 415-455 nanometers (known

as Blue-Violet light) while permitting the rest of the visible spectrum including beneficial blue light (known as Blue-Turquoise light), to enter the eye at a normal level. Thus, the eye’s necessary visual and non-visual functions can be maintained while exposure to hazardous wavelengths is reduced.

Crizal® Previncia™ No-Glare lenses with Light Scan™

represent the first application of new patented technology¹, that enables selective filtration of harmful light – both Blue-Violet (BV) and Ultraviolet (UV) – while allowing beneficial light to pass through and maintaining exceptional transparency at all other visible-

light wavelengths. In fact, Crizal Previncia No-

Glare lenses reduce the quantity of harmful

Blue-Violet light reaching the eye by

20%. Unlike common yellow-tinted

“blue blocking lenses,” Crizal

Previncia No-Glare lenses cause

minimal color distortion—

indeed, these lenses are almost

perfectly clear. Designed to

selectively block harmful

blue light while preserving

transmittance of beneficial blue

light, Crizal Previncia No-Glare

lenses offer the most selective eye

protection on the market today.



Additionally, Crizal Previncia No-Glare lenses

also feature an Eye-Sun Protection Factor (E-SPF®) of 25, which means they provide

25 times more UV protection for the eye than wearing no lens at all. Integrating Essilor’s superior No-Glare technology, Crizal® lenses are easy to clean, resistant to smudges, scratches, dust, and water, and protect against distracting glare and reflections. Maintaining excellent transparency, Crizal Previncia No-Glare lenses offer optimal vision at all times.



1. Covered under U.S. Patent No. 8,360,574. Additional U.S. and foreign patents pending.

©2014 Essilor of America, Inc. All Rights Reserved. Unless indicated otherwise, all trademarks are the property of Essilor International and/or its subsidiaries. E-SPF and the 25 E-SPF design are registered trademarks of Essilor of America, Inc. E-SPF is a global index developed by Essilor, endorsed by independent third parties, measuring the lens’ UV protection excluding direct eye exposure from around the lens. E-SPF of 25 means the wearer is 25 times more protected than without any lens. E-SPF of 25 when Crizal is made with any lens material other than clear 1.5 plastic. Essilor Crizal Previncia lenses are Class I medical devices intended for the correction of ametropias and presbyopia and offering selective protection from harmful blue light and UV rays. The Blue-Violet cut may slightly differ depending on lens material. Essilor informs you that the above information is general information given as prevention and public awareness. For more information, Essilor invites you to consult a healthcare professional (eye doctor, ophthalmologist).

Today, she presents
with dry eye symptoms.



nicox 
Ophthalmic Diagnostics

Sjögren's
Syndrome
SSF Foundation

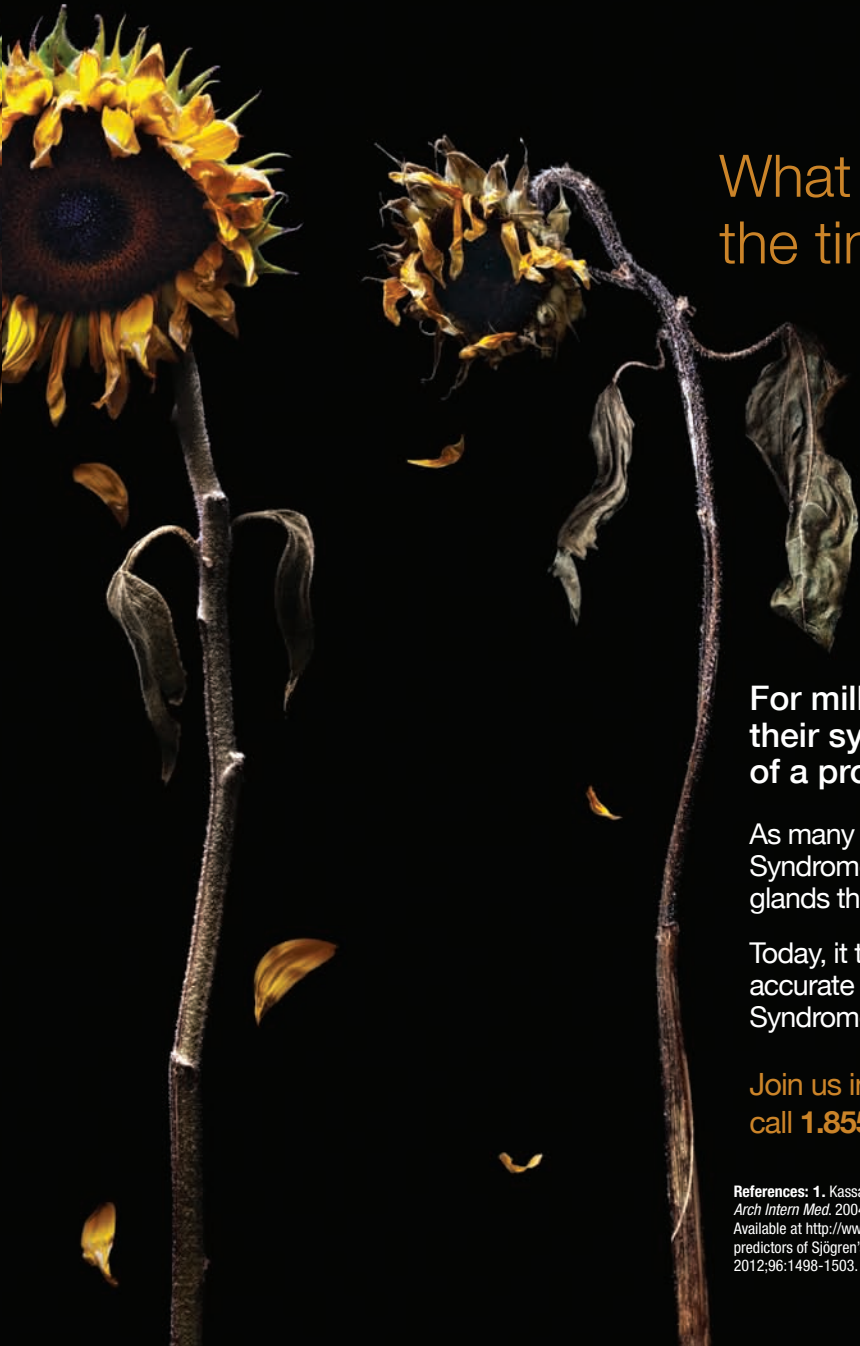

What will she look like by
the time she is diagnosed?

For millions of dry eye patients,
their symptoms could be an early sign
of a progressive autoimmune disease.^{1,2}

As many as 1 in 10 patients with dry eye also have Sjögren's
Syndrome, a chronic condition of deteriorating exocrine
glands that can have significant systemic ramifications.²⁻⁴

Today, it takes an average of 4.7 years to receive an
accurate diagnosis.² Together with the Sjögren's
Syndrome Foundation, Nicox is out to change that.

Join us in the fight at morethandryeye.com, or
call **1.855.MY.NICOX** (1.855.696.4269) to learn more.

References: 1. Kassan SS, Moutsopoulos HM. Clinical manifestations and early diagnosis of Sjögren syndrome. *Arch Intern Med.* 2004;164:1275-1284. 2. Sjögren's Syndrome Foundation. Sjögren's Syndrome Foundation. 2001. Available at <http://www.sjogrens.org>. Accessed September 5, 2013. 3. Liew M, Zhang M, Kim E, et al. Prevalence and predictors of Sjögren's syndrome in a prospective cohort of patients with aqueous-deficient dry eye. *Br J Ophthalmol.* 2012;96:1498-1503. 4. Martin LS, Massafra U, Migliore A. Sjögren's syndrome: an under-diagnosed disorder. *CLJ.* May 2004.

January

Sunday	Monday	Tuesday	Wednesday	Thursday	Friday	Saturday
			1	2	3	4
5 • Eye-To-Eye	6	7	8	9	10	11 • 2014 Glaucoma Symposium • Coding Update & HIPAA/HR Compliance • Eye Care Associates Annual Mtg.
12 • Eye Care Associates Annual Mtg. • Illinois Opt. Assn. Winter CE • SCCO Anterior & Posterior Segment	13	14	15	16 • New Technologies and Treatments in Vision Care	17	18 • Tropical CE • Gold Coast Educational Retreat • Berkeley Practicum • Kraskin Skeffington Symposium
19 • New Technologies and Treatments	20	21	22	23	24 • Oregon Opt. Phys. Assn. 2014 Winter CE	25 • Battle on the Beach Revisited
• 2014 Island Eyes Conference						
• Gold Coast Educational Retreat • Berkeley Practicum • Kraskin Skeffington Symposium		• Sacramento Valley Optom. Society		• Global Specialty Lens Symposium • High Performance Vision/Sports Vision • Vision Training Conference II		
• Tropical CE Costa Rica						
26 • Global Specialty Lens Symposium • Illinois Opt. Assn. Winter CE • Virginia Opt. Assn.	27	28	29	30 • Women of Optometry Spa Cruise	31	

Jan. 5, New York City

Eye-To-Eye

HOST: Review of Optometry
KEY FACULTY: Ron Melton, Randall Thomas
CE HOURS: 3
LOCATION: The Yale Club of New York City
50 Vanderbilt Avenue
CONTACT: Lois DiDomenico
reviewmeetings@jobson.com
www.revoptom.com/conferences

AL CD DE EL GL IN PH

Jan. 11, Woodinville, WA

2014 Glaucoma Symposium

HOST: Pacific University College of Optometry

KEY FACULTY: Howard Barnebey, Murray Fingeret
CE HOURS: 7
LOCATION: Willows Lodge, 14580 NE 145th Street
CONTACT: Marti Fredericks
rederim@pacificu.edu
(503) 352-2929
www.pacificu.edu/optometry/ce
GL

Jan. 11, Little Rock, AK

Coding Update & HIPAA & HR Compliance Training

HOST: Arkansas Optometric Assn.
KEY FACULTY: John A. McGreal, Joe DeLoach, B.J. Avery
CE HOURS: 8

LOCATION: Doubletree Hilton, 424 W. Markham Street
CONTACT: Vicki Farmer
aroa@arkansasoptometric.org
501-661-7675
www.arkansasoptometric.org
PM

Jan. 11-12, Williamsburg, VA

Eye Care Associates Annual Meeting and Continuing Education Program

HOST: Eye Care Associates
KEY FACULTY: Scot Morris
CE HOURS: 12
LOCATION: Williamsburg Hotel
CONTACT: Linda Cavasos
ECA_linda@hotmail.com
(804) 356-5165

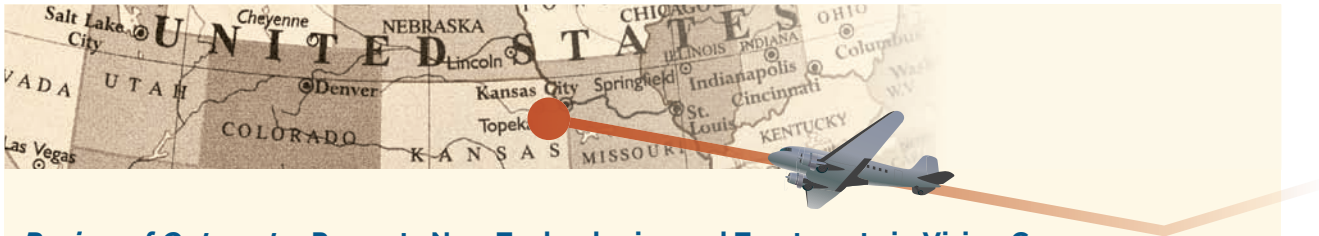

Review of Optometry Presents New Technologies and Treatments in Vision Care

As busy clinicians, the opportunities to discuss and share with colleagues the finer points and unique insights on how you practice your craft are often infrequent. This is one of the reasons Review of Optometry will continue to offer its New Technologies and Treatments series, which will provide an interactive forum to discuss new pharmaceuticals and instruments that are continuing to evolve and move the profession forward.

“One unique aspect of these innovative meetings is their informal nature, which acts as a catalyst to spur conversation amongst colleagues,” says optometrist Paul Karpecki, education meeting chair. “The collaborative experiences available to us at well-focused CE conferences are precisely how we improve and hone our clinical acumen, both individually and collectively as a profession.”

Five meetings in all will be held in 2014. Some topics to be featured during the New Technologies and Treatments meeting series will include glaucoma diagnosis and management, anterior segment grand rounds, technological innovations in eye care, ocular manifestations of systemic disease, ocular surface disease diagnosis and treatment, new pharmaceuticals and ocular nutrition. The educational faculty includes many of the thought leaders in the profession.

“As education chair, I have seen first-hand how education has flourished at these informal settings, and when



the meetings conclude, we have returned to our practices invigorated with renewed fervor for patient care,” Dr. Karpecki adds.

The meeting series will be held throughout the year at these locations:

- **Jan. 16-19, Palm Beach, Aruba**, at the Westin Resort & Casino, with faculty that includes Jimmy Bartlett, OD, Ben Gaddie, OD, and Kimberly Reed.

Fourteen CE credit hours will be available.

- **May 2-4, La Jolla, CA**, at the Hilton La Jolla Torrey Pines, with faculty that includes Jeffrey Gerson, OD, Ron Melton OD, and Randall Thomas, OD. Fifteen CE credit hours will be available.

- **June 19-22, Orlando, FL**, at Disney’s Yacht & Beach Club, with faculty that includes Steve Ferrucci, OD, Marc Bloomenstein, OD, and Doug Devries, OD. Fourteen CE credit hours will be available.

- **July 17-20, Minneapolis, MN**, at the Hilton Minneapolis, with faculty that includes Paul Ajamian, OD, Joseph Shovlin, OD, and Robert Wooldridge, OD. Fourteen CE credit hours will be available.

- **Sept. 12-14, Tysons Corner, VA** (Washington, DC area), at the Sheraton Premiere, with faculty that includes Al Kabat, OD, Derek Cunningham, OD, and Mark Dunbar, OD. Fifteen CE credit hours will be available.

For more details or to register, contact Lois DiDomenico, ReviewMeetings@Jobson.com, 866-658-1772.

Jan. 12, Rosemont, IL IOA Winter CE

HOST: Illinois Optometric Association
KEY FACULTY: Paul Karpecki
CE HOURS: 6
LOCATION: Hyatt Regency O’Hare
CONTACT: Charlene Marsh
ioabb@ioaweb.org
217-525-8012
www.ioaweb.org
CD

KEY FACULTY: George Comer, Steven Ferrucci, Justin Kwan, John Nishimoto, Judy Tong, Barry Weissman
CE HOURS: 7
LOCATION: Marshall B. Ketchum University, 2575 Yorba Linda Blvd.
CONTACT: Antoinette & Bonnie ce@ketchum.edu
714-449-7495
www.ketchum.edu/ce
AL CD CS DE IN RE SD

HOST: Review of Optometry
KEY FACULTY: Paul Karpecki, Jimmy Bartlett, Ben Gaddie, Kimberly Reed
CE HOURS: 14
LOCATION: The Westin Resort & Casino, J.E. Irausquin Blvd. 77
CONTACT: Lois DiDomenico
reviewmeetings@jobson.com
www.revoptom.com/conferences
AL CD DE EL GL NT IN PH SD

Jan. 12, Fullerton, CA Anterior & Posterior Segment

HOST: SCCO at Ketchum University

**Jan. 16-19, Palm Beach, Aruba
New Technologies and Treatments in Vision Care**

Jan. 18-25, Costa Rica Tropical CE Costa Rica

HOST: Tropical CE
KEY FACULTY: R. Melton, R. Thomas

CE HOURS: 20
LOCATION: La Fortuna de San Carlos
CONTACT: R. Stuart Autry
sautry@tropicalce.com
281-808-5763
www.tropicalce.com
CD GL NO IN PH SD

**Jan. 18-19, Fort Lauderdale
30th Annual Gold Coast
Educational Retreat**

HOST: Broward County Opt. Assn.
KEY FACULTY: Joseph Shovlin,
Joseph Sowka, Albert Woods, Stanley
Braverman, Robert Easton
CE HOURS: 19
LOCATION: Hyatt Regency Pier 66,
2301 S.E. 17th Street
CONTACT: Lori Volmer
BCOA@browardeyes.org
www.browardeyes.org/
AL CM CL CD CS CT DB DE EL GL NO NT
IN PH PM RE SD VT

**Jan. 18-20, Berkeley, CA
Berkeley Practicum, 25th Annual**

HOST: University of California, Berke-
ley, School of Optometry
KEY FACULTY: Todd Margolis
CE HOURS: 20
LOCATION: DoubleTree Hotel,
Berkeley Marina,
200 Marina Blvd.
CONTACT: Danni Peck
optoCE@berkeley.edu
800-827-2163
[http://optometry.berkeley.edu/ce/
berkeley-practicum](http://optometry.berkeley.edu/ce/berkeley-practicum)
CD DE EL GL IN PH RE SD

**Jan. 18-20, Bethesda, MD
Kraskin Invitational Skeffington
Symposium on Vision**

HOST: OEPF
CE HOURS: 19
LOCATION: Hyatt Regency Bethesda,
One Bethesda Metro Center
CONTACT: Jeffrey Kraskin
jkraskin@rcn.com
202-363-4450
www.SkeffingtonSymposium.org
AM BV NO NT PE PM VT

**Jan. 19-25, Maui, Hawaii
2014 Island Eyes Conference**

HOST: Pacific Univ. College of Optom.
KEY FACULTY: Les Walls, Jay Haynie,
Patrick Caroline, James Kundart,
Sharon Wong, Jennifer Smythe, Ken
Eakland, Fraser Horn
CE HOURS: 25
LOCATION: Grand Wailea,

3850 Wailea Alanui Drive
CONTACT: Jeanne Oliver
jeanne@pacificu.edu
(503) 352-2740
www.pacificu.edu/optometry/ce
BV CM CL CS NT PE RE RS SD

**Jan. 21, Sacramento, CA
Sacramento Valley Optometric
Society General Meeting**

HOST: Sacramento Valley Optometric
Society
LOCATION: Red Lion Woodlake Hotel
CE HOURS: 2
CONTACT: Jerry Sue Hooper
jerrysue13@comcast.net
916-447-0270

**Jan. 23-26, Las Vegas
Global Specialty Lens Symposium**

HOST: Contact Lens Spectrum
CE HOURS: 30
LOCATION: Rio Hotel and Casino
CONTACT: Maureen Platt
maureen.platt@pentavisionmedia.com
215-628-7754
www.pentavisionevents.com
CL

**Jan. 24, Portland, OR
OOPA 2014 Winter CE**

HOST: Oregon Optometric Physicians
Association
CE HOURS: 8
CONTACT:
lynne@oregonoptometry.org
www.oregonoptometry.org

**Jan. 24-25, Hollywood, FL
High Performance Vision/Sports
Vision Consulting Weekend**

HOST: Ultimate Events, LLC
KEY FACULTY: Don Teig
CE HOURS: 16
LOCATION: Hollywood Beach
Marriott, 2501 North Ocean Drive
CONTACT: Don Teig
don@ultimateeventsllc.com
203-312-3123
www.ultimateeventsllc.com
BV CM CD EL NT IN DS PE PH PM

**Jan. 25, Miami, FL
Battle on the Beach Revisited:
What's New and What's Really True**

HOST: Bascom Palmer Eye Institute
KEY FACULTY: Bascom Palmer Eye
Institute and Guest Faculty
CE HOURS: 7.5
LOCATION: Mandarin Oriental Miami,
500 Brickell Key Drive
CONTACT: CME Department

bpeicme@med.miami.edu
305-326-6110
[http://bascompalmer.org/cme/glau-
coma](http://bascompalmer.org/cme/glau-
coma)
GL NO

**Jan. 25-26, Independence, OH
Vision Training Conference II**

HOST: College of Optometrists in
Vision Development
KEY FACULTY: W.C. Maples
CE HOURS: 12
LOCATION: Embassy Suites,
5800 Rockside Woods Blvd.
CONTACT: Jackie Cencer
jcencer@covd.org
330-995-0718
www.covd.org
VT

**Jan. 26, Wheeling, IL
Winter CE**

HOST: Illinois Optometric Association
KEY FACULTY: Ben Gaddie
CE HOURS: 6
LOCATION: The Westin Chicago
North Shore
CONTACT: Charlene Marsh
ioabb@ioaweb.org
217-525-8012
www.ioaweb.org
CD GL

**Jan. 26, Glen Allen, VA
VOA One-Day CE Conference**

HOST: Virginia Optometric Assn.
KEY FACULTY: Joe DeLoach, B.J.
Avery
CE HOURS: 4
LOCATION: Richmond Marriott West
4240 Dominion Boulevard
CONTACT: Bruce Keeney
office@thevoa.org
804-643-0309
www.thevoa.org
CD GL RE

**Jan. 30-Feb. 3, Bahamas
Women of Optometry Spa Cruise**

HOST: Women of Vision and AEA
Cruises
KEY FACULTY: Kimberly Reed, Louise
Sclafani, Christine Sindt
CE HOURS: 8
LOCATION: Celebrity Constellation
CONTACT: Marge McGrath
aeacruises@aol.com
773-594-9866; 888-638-6009
www.optometriccruiseseminars.com
CL SD



THE TRAINING YOU NEED TO GROW YOUR MEDICAL PRACTICE

Attention All Optometrists

Attend a boot camp to receive a step-by-step implementation plan that will take your practice to the next level by:

- Taking charge of your schedule
- Determining vision plan vs medical plan
- Gaining access to insurance panels
- Improving billing and medical records
- Understanding ICD-10 codes
- Maximizing practice productivity and performance

Expert faculty:

Scot Morris, OD, FAAO
John Rumpakis, OD, MBA
Allergan Eye Care Business Advisors

Register today at AllerganODPathways.com

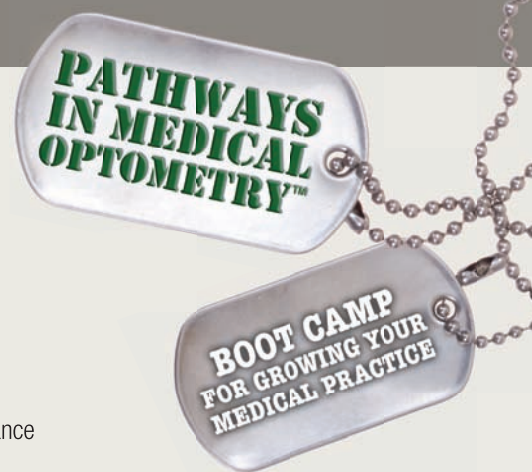

Upcoming PATHWAYS IN MEDICAL OPTOMETRY™ Course Schedule

City	Level 1	Level 2
Charlotte, NC	Sat, 2/1/14	Sat, 4/12/14
Atlanta, GA	Tue, 3/11/14	Sat, 5/17/14
Columbus, OH	Sat, 4/19/14	Sat, 6/21/14
Pittsburgh, PA	Sat, 5/31/14	Sat, 8/2/14
Seattle, WA	Sat, 8/9/14	Sat, 10/18/14
Dallas, TX	Sat, 9/13/14	Sat, 11/8/14

Level 1 is a prerequisite to Level 2. Each boot camp consists of 1 full-day course.

Cost per course:

*First OD registration per practice
\$399 per course**

*All additional practice registrations
\$199 per course**

**Costs required per PhRMA guidelines.*



February

Sunday	Monday	Tuesday	Wednesday	Thursday	Friday	Saturday
						1 <ul style="list-style-type: none"> Windsor CE Seminar
2 <ul style="list-style-type: none"> Windsor CE Seminar Illinois Opt. Assn. Winter CE 	3	4	5 <ul style="list-style-type: none"> Indiana Optometry Winter Seminar Michigan Opt. Assn. Winter Seminar 	6	7	8 <ul style="list-style-type: none"> AAO Arizona Chapter Opt. Assn. of Louisiana Mid-Winter Conference
VT/Learning-related Visual Problems						
9 <ul style="list-style-type: none"> Oregon Optometric Physicians Association Advocacy Boot Camp Opt. Assn. of Louisiana Mid-Winter Conference VT/Learning-related Visual Problems 	10	11	12	13	14 <ul style="list-style-type: none"> Heart of America Contact Lens Society 	15 <ul style="list-style-type: none"> SCCO Glaucoma Case Management SkiVision 2014 Southern Caribbean Cruise Seminar
16 <ul style="list-style-type: none"> Heart of America Contact Lens Society SCCO Glaucoma Case Management 	17	18 <ul style="list-style-type: none"> Sacramento Valley Optom. Society 	19	20	21	22 <ul style="list-style-type: none"> Tropical CE Playa del Carmen
SkiVision 2014						
Southern Caribbean Cruise Seminar						
Eastern Caribbean Cruise Seminar						
23 <ul style="list-style-type: none"> Eastern Caribbean Cruise Seminar Illinois Opt. Assn. Winter CE Indiana University Glaucoma Series 	24	25	26	27 <ul style="list-style-type: none"> Montana Opt. Assn. Winter Symposium 	28	
Tropical CE Playa del Carmen						

**Feb. 1-2, Windsor, Ontario
Windsor CE Seminar**

HOST: The Academy of Ophthalmic Education
 KEY FACULTY: Ron Melton, Randall Thomas, Ben Gaddie
 CE HOURS: 14
 LOCATION: University of Windsor, Anthony P. Toldo Health Education Centre, 401 Sunset Avenue, #104
 CONTACT: Claudia Marks
cmarks@aoece.com
 905-731-6022
www.aoece.com
 BV GL IN PH PM SD

**Feb. 2, Tinley Park, IL
IOA Winter CE**

HOST: Illinois Optometric Association
 KEY FACULTY: Robert Dunphy, OD
 CE HOURS: 6
 LOCATION: Tinley Park Convention Center
 CONTACT: Charlene Marsh
ioabb@ioaweb.org; 217-525-8012
www.ioaweb.org
 CD RS

**Feb. 5, Carmel, IN
Indiana Optometry Winter Seminar**

HOST: Indiana Optometric Assn.
 KEY FACULTY: Etty Bitton, James Thimons, Steven Holbrook
 CE HOURS: 7
 LOCATION: Ritz Charles, 12156 N. Meridian
 CONTACT: Bridget Sims
blsims@ioa.org
 315-237-3560
www.ioa.org
 CL CT DE GL PH

**Feb. 5-6, East Lansing, MI
Michigan Optometric Association
Winter Seminar**

HOST: Michigan Optometric Assn.
CE HOURS: 12
LOCATION: Kellogg Hotel and
Conference Center
CONTACT: Amy Root
amy@themoa.org
517-482-0616
www.themoa.org

**Feb. 5-9, Phoenix, AZ
Vision Therapy/Learning Related
Visual Problems**

HOST: Optometric Extension Pro-
gram Foundation
KEY FACULTY: Robin D. Lewis
CE HOURS: 35
LOCATION: Office of Rob Lewis, OD
2950 N Dobson, Suite 111
CONTACT: Karen Ruder
Karen.Ruder@verizon.net
410-561-3791
www.oepf.org
BV VT

**Feb. 8, Glendale, AZ
American Academy of Optometry,
Arizona Chapter**

HOST: Midwestern University,
Arizona College of Optometry
KEY FACULTY: Christina Sorenson,
Sunny Sanders, Greg Wolfe, Lori Gro-
ver, Wendy Harrison, Larry Richardson
CE HOURS: 2
LOCATION: Midwestern University,
Arizona College of Optometry,
19379 N. 59th Ave.
CONTACT: Tina Porzukowiak
tporz@midwestern.edu
623-806-7225
CL CD NO RE SD

**Feb. 8-9, New Orleans
Mid-Winter Conference**

HOST: Optometry Assn. of Louisiana
KEY FACULTY: Southern College of
Optometry Faculty
CE HOURS: 12
LOCATION: Marriott Hotel
CONTACT: Jim Sandefur
optla@bellsouth.net
318-335-0675
www.optla.org
AL EL GL PH PM

**Feb. 9-10, Salem, OR
2014 Advocacy Boot Camp & CE**

HOST: Oregon Optometric Physicians
Association
CE HOURS: 2
LOCATION: Salem Conference
Center/Grand Hotel
CONTACT: lynne@oregonoptometry.org
www.oregonoptometry.org



CE on the Sea

Being able to soak up sun, sights and education is a wonderful experience, especially if the venue is a luxury cruise ship. Be sure to explore these CE cruise opportunities scheduled in 2014:

• **Women of Optometry Spa**

Cruise to Bermuda: Jan. 30-Feb. 14 aboard the Celebrity Constellation. Earn eight CE hours and sit in on courses presented by optometrists Kimberly Reed, Louise Sclafani and Christine Sindt, who will cover topics on contact lenses and systemic disease. Hosted by AEA cruises, www.OptometricCruiseSeminars.com.

• **Southern Caribbean Cruise**

Seminar: Feb. 15-22 aboard the Celebrity Summit. Gain 10 hours of CE and listen to courses by Charles Ficco, OD. Hosted by AEA Cruises, www.OptometricCruiseSeminars.com.

• **Eastern Caribbean Cruise Semi-**

nar: Feb. 16-23 aboard the Royal Princess. S. Barry Eiden, OD, is the headliner for this cruise, where attendees can earn up to 10 CE credits. Hosted by AEA Cruises, www.OptometricCruiseSeminars.com.

• **Mediterranean Cruise Seminar**

from Athens to Venice: May 10-19 aboard Silversea's Silver Wind. Ten CE credits will be available, with presentations by Louise Sclafani, OD, and Mark Rosanova, MD. Hosted by AEA Cruises, www.OptometricCruiseSeminars.com.

• **Alaska Inside Passage Cruise**

Seminar: June 29-July 9 aboard the Grand Princess, where 10 hours of CE will be available. Hosted by AEA Cruises, www.OptometricCruiseSeminars.com.

**Feb. 14-16, Kansas City
53rd Annual Heart of America
Contact Lens Society Congress**

HOST: Heart of America Contact
Lens Society
KEY FACULTY: Jimmy Bartlett, Randy

• **Paris/Normandy/Seine River**

Cruise Seminar: July 3-10 aboard the AmaWaterways Amalegro. Attendees will be able to obtain 10 CE credits in courses given by Peter Kehoe, OD. Hosted by AEA Cruises, www.OptometricCruiseSeminars.com.

• **Splendid China 2014 CE:** July

5-18 cruise to Hong Kong, Guilin, Chengdu and Tibet. Featured speakers include Joseph Pizzimenti, OD, and Mile Brujic, OD. Twenty-four hours of CE credit will be available. Topics will be allergy, comanagement, contact lenses, corneal/conjunctival disease, corneal surgery, cataract surgery, diabetes, dry eye, nutrition and the eye, ocular infection, optical dispensing, pharmacology, practice management, retinal disorders, refractive surgery and systemic disease. Hosted by iTravelCE. For more information: info@iTravelCE.com or go to www.iTravelCE.com.

• **Scandinavia/Russia Cruise**

Seminar: July 6-17 aboard the Royal Princess. Attendees can earn up to 10 CE credits. Hosted by AEA Cruises, www.OptometricCruiseSeminars.com.

• **Mediterranean Cruise Continu-**

ing Education Seminar: Aug. 16-23 aboard the Royal Caribbean's Splendour of the Seas cruise to Italy, Croatia, Turkey and the Greek Islands. Dr. Scot Morris will present courses covering comanagement, glaucoma, ocular infections, optical dispensing, practice management and retinal disorders. Fourteen hours of CE are available. Hosted by the Academy of Ophthalmic Education.

For more information, contact, Claudia Marks cmarks@aoece.com or go to www.aoece.com.

Kojima, John McSoley, John McGreal
Leo Semes
CE HOURS: 15 OD, 11 paraoptometric
LOCATION: Sheraton Kansas City
Hotel at Crown Center
2345 McGee Street

CONTACT: Ron Fiegel
registration2@thehoacsls.org
316-729-8900
www.hoacsls.org

AL BV CM CL CD CT DB DE EL GL NO IN
PE PH PM RE RS SD

Feb. 15-16, Fullerton, CA

Glaucoma Case Management

HOST: SCCO at Ketchum University
KEY FACULTY: George Comer, Steven Ferrucci, Mark Sawamura, Judy Tong
CE HOURS: 15
LOCATION: Marshall B. Ketchum University 2575 Yorba Linda Blvd.
CONTACT: Antoinette & Bonnie
ce@ketchum.edu
714-449-7495
www.ketchum.edu/ce

GL

Feb. 15-19, Snowmass Village, CO SkiVision 2014 Winter Congress

HOST: SkiVision
KEY FACULTY: Murray Fingeret, Leo Semes, Ben Gaddie, Robert Fechtner, Jack Schaeffer, Kathy Dumbleton
CE HOURS: 20
LOCATION: Viceroy Luxury Resort Hotel, 130 Wood Road
CONTACT: Andrew Archila
Questions@skivision.com
888-SKI-2530/888-754-2530
www.skivision.com

CM CL CD DE GL NO PM SD

Feb. 15-22, Southern Caribbean Southern Caribbean Cruise Seminar

HOST: AEA Cruises
KEY FACULTY: Charles Ficco
CE HOURS: 10
LOCATION: Celebrity Summit
CONTACT: Marge McGrath
aecruises@aol.com
773-594-9866; 888-638-6009
www.optometriccruiseseminars.com

Feb. 16-23, Eastern Caribbean Eastern Caribbean Cruise Seminar

HOST: AEA Cruises
KEY FACULTY: S. Barry Eiden
CE HOURS: 10
LOCATION: Royal Princess
CONTACT: Marge McGrath
aecruises@aol.com
773-594-9866; 888-638-6009
www.optometriccruiseseminars.com

Feb. 18, TBD, CA Sacramento Valley Optometric Society General Meeting

HOST: Sacramento Valley Opt. Soc.
CE HOURS: 2
CONTACT: Jerry Sue Hooper
jerrysue13@comcast.net
916-447-0270

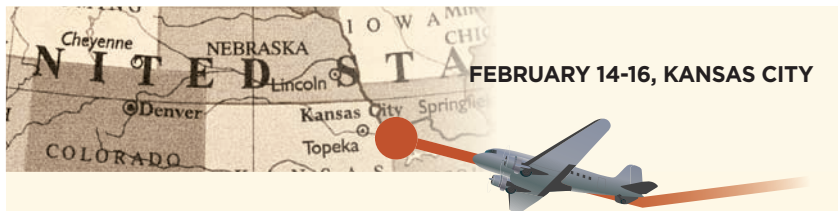

Heart of America Contact Lens Society & Primary Care Congress

Optometrists in the heartland will have the opportunity to earn up to 15 hours of CE credit presented by numerous heavy-hitters on the lecture circuit during the 53rd annual Heart of America Contact Lens & Primary Care Congress. The meeting, which will also offer 11 hours of CE for paraoptometrics, will be held from Feb. 14-16 in Kansas City at the Sheraton Kansas City Hotel at Crown Center.

Topics to be covered include specialty contact lenses, glaucoma, pharmacology, pediatrics, anterior segment disorders, neurology, retinal disorders, practice management and diabetes. The congress' early-bird panel discussion, "Advancements in Eye Care Research," will feature Lyndon Jones, PhD, Jeff Gerson, OD, and Leo Semes, OD, who will review the latest hot topics in current clinical

research. The opening symposia will be "Contemporary Management of Ocular Inflammation and Allergy" by Jimmy Bartlett, OD, and "The New Normal— Getting More From Your Team in the New Era of Eye Care," by Tom Bowen, BS. In addition to continuing education, the congress also boasts the largest exhibit hall in the Midwest.

Every year, Heart of America applies for approval of CE credit in each state, simplifying re-licensure for attendees. The congress will continue to offer the OE Tracker scanning system to assist doctors in tracking their CE hours and verify attendance. Additionally, Heart of America returns almost \$100,000 to the five member state associations and other states that have 25 or more doctors attending each year.

For more information or to register, go to www.hoacsls.org.

Feb. 22-Mar. 1, Playa del Carmen Tropical CE Playa del Carmen

HOST: Tropical CE
KEY FACULTY: John McGreal, Kevin Gee
CE HOURS: 20
LOCATION: Secrets Maroma Beach
CONTACT: R. Stuart Autry
sautry@tropicalce.com
281-808-5763
www.tropicalce.com
CM CL PH PM RS SD

Feb. 23, Bloomington, IL Winter CE

HOST: Illinois Optometric Association
KEY FACULTY: Joe Pizzimenti
CE HOURS: 6
LOCATION: Marriot Bloomington-Normal Hotel
CONTACT: Charlene Marsh
ioabb@ioawewb.org
217-525-8012
www.ioawewb.org
RE

Feb. 23, Bloomington, IN Glaucoma Series

HOST: Indiana University
KEY FACULTY: Brett King, Neil Pence
CE HOURS: 6
LOCATION: Indiana University School of Optometry, 800 E. Atwater
CONTACT: Cheryl Oldfield
coldfiel@indiana.edu
812-856-3502
www.opt.indiana.edu/ce/seminars.htm
GL

Feb. 27-Mar. 1, Big Sky, MT 2014 Winter Educ. Symposium

HOST: Montana Optometric Association
KEY FACULTY: Blair Lonsberry, Christopher Wolfe
CE HOURS: 13
LOCATION: Huntley Lodge, 1 Lone Mountain Trail
CONTACT: Sue Weingartner
sweingartner@rmsmanagement.com
(406) 443-1160
www.mteyes.com
BV CL CD GL IN PE PH RE SD



Well beyond comfortable...
The only lens shown to be
clinically comparable to wearing

NO LENS AT ALL

ON 5 OF 6 KEY MEASURES
OF OCULAR HEALTH*†1:

- Limbal hyperemia
- Corneal staining
- Corneal vascularization
- Bulbar conjunctival hyperemia
- Papillary conjunctivitis

The sixth measure was conjunctival staining which differed between the lens wearers and spectacle wearers; however, both measures were very low and of limited clinical relevance.

1-DAY ACUVUE®
TruEye®
BRAND CONTACT LENSES

HEALTH YOU CAN SEE™

Go beyond ocular comfort
and help maintain ocular health.

*A 1-year, randomized, investigator-masked, parallel-group study of 74 subjects (aged 18-51 years) who had never worn soft contact lenses previously. Subjects were randomized to 1-DAY ACUVUE® TruEye® Brand or spectacles. Ocular physiology was assessed at 2 weeks, 1 month, 3 months, 6 months, 9 months, and 1 year using the Efron Grading Scale (a 0- to 4-point scale, with findings recorded to the nearest 0.1). $P < 0.05$ based on 2-sided 95% confidence intervals.

†The sixth measure was conjunctival staining.

ACUVUE® Brand Contact Lenses are indicated for vision correction. As with any contact lens, eye problems, including corneal ulcers, can develop. Some wearers may experience mild irritation, itching or discomfort. Lenses should not be prescribed if patients have any eye infection, or experience eye discomfort, excessive tearing, vision changes, redness or other eye problems. Consult the package insert for complete information. Complete information is also available from VISTAKON® Division of Johnson & Johnson Vision Care, Inc., by calling 1-800-843-2020 or by visiting acuvueprofessional.com.

Reference: 1. Morgan P, Chamberlain P, Moody K, et al. Ocular physiology and comfort in neophyte subjects fitted with daily disposable silicone hydrogel contact lenses. *Cont Lens Anterior Eye*. 2013;36(3):118-125.

ACUVUE®, 1-DAY ACUVUE® TruEye®, HEALTH YOU CAN SEE™, and VISTAKON® are trademarks of Johnson & Johnson Vision Care, Inc.

© Johnson & Johnson Vision Care, Inc. 2013 ACU-324401 July 2013

March

Sunday	Monday	Tuesday	Wednesday	Thursday	Friday	Saturday
						1 • SCCO Ocular Disease: Part 1
2 • SCCO Ocular Disease: Part 1 • Sacramento Valley Optom. Soc. • SCCO Glaucoma Grand Rounds	3	4	5	6	7	8 • Eye-To-Eye
			• Eye Ski Conference			
9	10	11	12	13	14	15
			• AFOS at SECO 2014			
			• SECO 2014			
						• OSU Binocular Vision Forum
16 • AFOS at SECO 2014 • SECO 2014	17	18	19	20	21	22
• COVD at SECO 2014						• PA Opt. Assn. Spring Conference
						• CE in the SW
						• Eye-To-Eye
						• Nova Ft. Myers Spring Conference
23 • POA Spring Conf.	24	25	26	27	28	29
• CE in the Southwest					• Vision Expo East	
• Eye-To-Eye					• OK Assn. of Opt. Physicians Spring Congress	
• Nova Ft. Myers Spring Conference					• OEP VT/Strabismus & Amblyopia	
					• PSS Conference on Comp. EyeCare	
					• IU Borish Symp.	
					• ONs at Vision Expo East	
30 • Vision Expo East	31					
• OEP VT/Strabismus & Amblyopia						
• PSS Conference on Comp. EyeCare						
• IU Borish Symp.						
• ONs at Vision Expo East						

**Mar. 1-2, Fullerton, CA
Ocular Disease: Part 1**

HOST: SCCO at Ketchum University
KEY FACULTY: Jeff Austin, Sue Cotter, Timothy Edrington, Steven Ferrucci, James Kundart, Justin Kwan, Dave Sendrowski, Judy Tong
CE HOURS: 17
LOCATION: Marshall B. Ketchum University, 2575 Yorba Linda Blvd.
CONTACT: Antoinette & Bonnie ce@ketchum.edu
714-449-7495

www.ketchum.edu/ce

AL CD DE EL GL NO NT IN PE PH RE SD
UV

**Mar. 2, Sacramento, CA
Ocular Symposium**

HOST: Sacramento Valley Opt. Society
CE HOURS: 8
LOCATION: 1920 12th Avenue
CONTACT: Jerry Sue Hooper
jerrysue13@comcast.net
916-447-0270

**Mar. 2-3, Fullerton, CA
Glaucoma Grand Rounds**

HOST: SCCO at Ketchum University
KEY FACULTY: George Comer, John Nishimoto, Mark Sawamura
CE HOURS: 16
LOCATION: Marshall B. Ketchum University, 2575 Yorba Linda Blvd.
CONTACT: Antoinette & Bonnie ce@ketchum.edu
714-449-7495
www.ketchum.edu/ce
GL

Mar. 2-7, Park City, UT
28th Annual Eye Ski Conference

HOST: Eye Ski
KEY FACULTY: Murray Fingeret, William Jones, Elliot Kirstein, Leonard Messner, James Fanelli, Joseph Pizzimenti, Lorraine Lombardi
CE HOURS: 20
LOCATION: The Lodge at Mountain Village
CONTACT: James Fanelli
faneleye@aol.com
910-452-7225
www.eyeskiutah.com
CD EL GL NO PH RE SD UV

Mar. 8, St. Louis
Eye-To-Eye

HOST: Review of Optometry
KEY FACULTY: Ron Melton, Randall Thomas
CE HOURS: 3
LOCATION: The Yale Club of New York City
50 Vanderbilt Avenue
CONTACT: Lois DiDomenico
reviewmeetings@jobson.com
www.revoptom.com/conferences
AL CD DE EL GL IN PH

Mar. 12-16, Atlanta
AFOS at SECO 2014

HOST: Armed Forces Optometric Society & Southern Council of Optometrists
KEY FACULTY: Leading Edge Optometric Educators
CE HOURS: 49
LOCATION: Westin Peachtree Plaza, Atlanta & Georgia World Congress Center, 210 Peachtree Street
CONTACT: Gina Borgognoni
execdir@afos2020.org
214-533-0227
www.afos2020.org
CD DB GL NO PH RE RS SD UV

Mar. 12-16, Atlanta
SECO 2014

HOST: SECO
CE HOURS: 400 total/41 maximum for ODs/29 AOP
LOCATION: Georgia World Congress Center
CONTACT:
<http://www.seco2014.com>
AL AM BV CM CL CD CS CT DB DE EL GL
NO NT IN DS PE PH PM RE RS SD UV VT

Mar. 14, Columbus, OH
Binocular Vision Forum

HOST: The Ohio State University College of Optometry
KEY FACULTY: Rachael Anastasia, Stacey Coulter
CE HOURS: 7

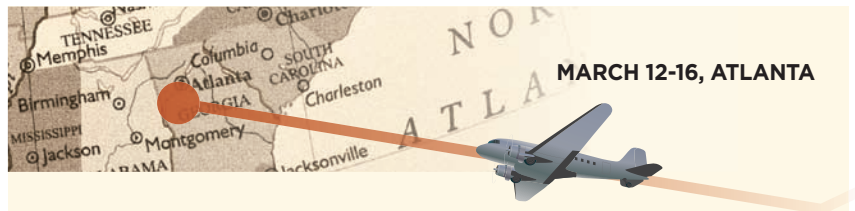

SECO 2014 Offers 400 Hours of CE in Atlanta

In CE circles, SECO's moniker as "the education destination" comes as no surprise, given its nearly century-long track record of putting on high-caliber educational programs. And for the 2014 meeting, to be held March 12-16 at the Georgia World Congress Center in Atlanta, SECO has lined up an impressive array of education, exhibits and social events for eye care professionals at all levels.

The meeting will feature 275 OD and AOP continuing education courses that collectively represent more than 400 credit hours. The OD program comprises 137 courses, including special sessions and a high-profile symposium series. The AOP program will offer 153 courses, including the "Beginning Your Life in the World of Ophthalmics" track and 10 team-centered learning courses designed for both ODs and AOPs. Additionally, Optometry's Marketplace at SECO will showcase the latest products and technologies from more than 250 industry-leading companies and host the expanded Advanced Media Learning Center.

"SECO 2014 offers a selection of courses that were carefully crafted to provide you with the latest information across the full spectrum of eye care," says Paul C. Ajamian, OD, optometric education program development committee chair. "You

will find everything you need in one meeting to position your practice for the future. Many of our courses, especially the special sessions for which SECO has become famous, will not be available at any other meeting, so take full advantage of this unique opportunity by making SECO your education destination."

Standouts at SECO 2014 include eight special sessions totaling 16 hours of CE credit. A few of the special sessions you won't want to miss:

- **"Breaking News from Bascom Palmer,"** by Mark Dunbar, OD, and Richard Awdeh, MD. This session will provide a glimpse into what the next 50 years holds for anterior segment eye care, including advances in cataract and refractive surgery, how to treat infections in the age of microbial resistance, and mobile health technology.

- **"Brushing the Surface: New Developments in MGD, Dry Eye and Infection,"** by optometrists Tammy Than, Kelly Nichols and Kimberly Reed. The trio will cover the latest in dry eye research and infectious keratitis, including mechanisms, diagnosis, testing, meibomian gland dysfunction and contemporary treatments.

- **"Ocular Oncology from Front to Back,"** presented by Vasiliki Poulaki,

(continued on page 20)



(continued from page 19)

MD, and Anthony Cavallerano, OD. The primary care optometrist is often confronted with decisions about suspicious adnexal, anterior segment and posterior segment lesions encountered as a routine part of a comprehensive eye exam.

This session presents a logical clinical approach to the differential diagnosis of ocular tumors and helps to sort out the important findings when making clinical decisions surrounding malignant and sometimes commonplace benign ocular neoplasms.

- **“Dr. Quigley’s Glaucoma Pearls.”** Harry Quigley, MD, a renowned glaucoma clinician and researcher at Johns Hopkins, will share his expertise and practical glaucoma “pearls” with attendees during this special session, moderated by Dr. Ajamian. In it, Dr. Quigley will review his latest research on angle-closure glaucoma, optic disc and nerve fiber layer evaluation, visual field loss, and the use of medications vs. surgery in open-angle glaucoma.

SECO has also assembled numerous comprehensive tracks with topics covering traumatic brain injury, pediatrics, oral pharmacology, practice management, AREDS2 and much more.

For more information or to register, go to <http://seco2014.com>.



Atlanta Happenings

If you have a few extra hours during SECO, be sure to make some time to visit these popular Atlanta venues:

- **World of Coca-Cola:** 121 Baker Street in Pemberton Place, www.worldofcoca-cola.com. Experience a hands-on history of the world’s most famous soft drink.

- **Georgia Aquarium:** 225 Baker Street, www.georgiaaquarium.org.

Take in the world’s largest aquarium, home to tens of thousands of marine animals and other sea life.

- **CNN Studio Tour:** 190 Marietta Street NW, www.cnn.com/tour.

Enjoy a 55-minute walking tour and see what happens behind the scenes at the first 24-7 news station.

- **Centennial Olympic Park:** 265 Park Avenue West NW, www.centennialpark.com. The 21-acre park was built to celebrate the legacy of the 1996 Centennial Olympic Games.

- **Dr. Martin Luther King, Jr. National Historic Site:** 450 Auburn Avenue, NE, www.nps.gov/malu. Walk along this 35-acre site and reflect upon a significant part of American history.

Restaurants to Try

There’s more to southern cookin’ than grits! Here are the best restaurants in Atlanta, according to Yelp:

- **Bacchanalia:** 1198 Howell Mill Road NW, www.starprovisions.com/bacchanalia.php

- **Quinones:** 1198 Howell Mill Road, www.starprovisions.com/quinones-at-bacchanalia.php

- **Canoe:** 4199 Paces Ferry Road NW, www.canoeatl.com.

- **Sotto Sotto:** 309 N Highland Avenue NE, www.urestaurants.com.

- **Aria:** 490 E Paces Ferry Road NE, www.aria-atl.com.

- **Desta Ethiopian Kitchen:** 3086 Briarcliff Road NE, www.destaethiopiankitchen.com.

- **Rathburn’s:** 112 Krog Street, www.rathbunsrestaurant.com.

- **South City Kitchen:** 1144 Crescent Avenue NE, midtown.southcitykitchen.com.

- **4th & Swift:** 621 N Avenue NE, 4thandswift.com.

- **Woodfire Grill:** 1782 Cheshire Bridge Road NE, www.woodfiregrill.com.

LOCATION: The Ohio State University College of Optometry, 338 West 10th Avenue

CONTACT: Marjean Kulp

kulp.6@osu.edu

614-688-3336

<http://optometry.osu.edu/CE/BVP-forum.cfm>

BV PE

Mar. 16-17, Atlanta COVID at SECO 2014

HOST: College of Optometrists in Vision Development

CE HOURS: 13

LOCATION: Omni Hotel at the CNN

Center 100 CNN Center

CONTACT: Jackie Cencer

jcencer@covid.org

330-995-0718

www.covid.org

VT

Mar. 21-23, State College, PA POA Spring Conference

HOST: PA Optometric Association

KEY FACULTY: Joe Sowka, Andy

Gurwood, Al Kabat

CE HOURS: 10

LOCATION: Nittany Lion Inn

CONTACT: Ilene Sauertieg

ilene@poaeves.org

717-233-6455

www.poaeyes.org

GL RE

Mar. 22-23, TBD Eye-To-Eye

HOST: Review of Optometry

KEY FACULTY: Ron Melton, Randall

Thomas

CE HOURS: 3

LOCATION: TBD

CONTACT: Lois DiDomenico

reviewmeetings@jobson.com

www.revoptom.com/conferences

AL CD DE EL GL IN PH

Mar. 22-24, Addison, TX Texas Educators Present CE in the Southwest

HOST: University of Houston College of Optometry and the Incarnate Word Rosenberg School of Optometry

CE HOURS: 16

LOCATION: Intercontinental Hotel 15201 Dallas Pkwy.

CONTACT: Amanda Johnson

ajohnson@optometry.uh.edu

713-743-1900

<http://ce.opt.uh.edu/>

(continued on page 24)

Tonometry Done Right



KAT
Keeler quality.



Pulsair Desktop
Smallest footprint and simple to use!

*Purchase a Pulsair Desktop by
March 31, 2014 and get
a \$1,300 Instant Rebate!*

Intellipuff
The standard for hand held mobility.

Buy Online!
keelerusa.com



Keeler
OPTICS



MARCH 26-30, NEW YORK CITY

Vision Expo East 2014

A flagship meeting for the optometric profession, Vision Expo East will offer more than 325 hours of continuing education this year for the thousands of attendees who will converge on New York City in late March at the Jacob Javits Center, the meeting's longstanding home. In addition to perusing the latest trends in optical fashion and lens design, attendees will learn about the latest diagnostic technologies, treatments and clinical studies that will ultimately impact their practice and their patients.

This year, one of the new and notable tracks at VEE will be "The Global Contact Lens Forum," which will provide seven hours of CE credit and will feature courses such as "Contact Lenses Yesterday, Today, and Tomorrow," by Mile Brujic, OD, Nick Rumney, OD, and Lyndon Jones, BSc, PhD, FCOptom.

Immediately preceding Vision Expo East 2014 will be a special event jointly organized by the British Contact Lens Association and Vision Expo.

The two organizations "have teamed up to present an exciting contact lens forum which will emphasize the business side of our contact lens practice," says VEE Chair Kirk Smick, OD. "Practitioners from both the US and across the pond in the UK will explore all aspects of the business side of a contact lens practice."

These classes will be presented on Wednesday afternoon and Thursday morning; the regular CE program begins immediately following on Thursday afternoon. "Attendees will leave the program saying, 'There is profit in a contact lens practice after all,'" Dr. Smick predicts.

VEE has also created an in-depth, 17-hour Glaucoma track, with lectures such as "Glaucoma and Eye Disease in Immigrant Populations," by Aaron Lech, OD, and also a 12-hour "Specialty Glaucoma" track that will include "Getting Comfortable with Glaucoma," presented by optometrists Leo Semes and Richard Madonna, and "Treatment Decisions-Part 1," by Harvey Dubiner, OD, and Michael Chaglasian, OD.

VEE will also help you steer your practice through new federal mandates in the "New Government Regulations & Healthcare Updates" track, which will offer 10 CE credits. You won't want to miss courses such as "Meaningful Use Stage 1 & 2," and "Surviving EHR Incentive Audits" by optometrists Phil Gross and Jay Henry.



Last year's AREDS2 results have created a buzz among optometrists, leaving many with more questions than answers. To address this need, VEE has created the "Macular Degeneration and Nutritional Supplements" track, which will provide 13 hours of CE credit and will include such courses as "Genetic Testing in Optometric Practice," by optometrist Ken Eckland. Another

notable course in this track is "Omega-3s in Primary Eye Care—What Should You Know Today," by John Lahr, OD.

Also new this year: VEE will co-host the annual Ocular Nutrition Society meeting, which will be held on Sunday and will feature several nationally recognized authorities on nutrition, who will present the latest research and information on nutraceuticals.

Attendees will also learn about diabetes and systemic disease, in addition to new technologies, in several custom-designed courses.

Another popular Vision Expo addition is back this year—My Show Planner, which allows attendees to personalize their meeting agenda from their mobile phone.

To learn more about Vision Expo East or to register, go to <http://www.visionexpoeast.com>.

Sightseeing in the Big Apple

New York City is global metropolis and an urban dynamo like no other, where sightseeing opportunities abound. You can't go to NYC without taking in:

(continued on page 24)

Correct the vision
rather than mask the problem.



KeraSoft® IC

Treating irregular corneas with anterior aspheric optics.

For keratoconus and other corneal irregularities, KeraSoft® IC provides vision correction by using anterior aspheric optics, and “drapes” over the cornea rather than using thickness of material to “mask” the irregularity. The patented design is customizable and offers balanced overall thickness with spherical aberration control. It features an adjustable periphery, allowing the lens to fit most any corneal shape. Made of silicone hydrogel* and with a Dk of 60, KeraSoft® IC soft contact lenses provide a comfortable option for your patients with irregular corneas.

Only available from your authorized KeraSoft® IC laboratories. Visit kerasoftic.com for details.

* Definitive material. © 2013 Bausch & Lomb Incorporated. ®/™ are trademarks of Bausch & Lomb Incorporated. All other product/brand names are trademarks of their respective owners. HL6250

KERASOFT® IC

ONLY FROM AUTHORIZED LABORATORIES

BAUSCH+LOMB

(continued from page 22)

- **Ellis Island:** Between 1892 and 1954, approximately 12 million people entering the United States through the port of New York were legally and medically inspected here. www.nps.gov/elis/index.htm
- **Broadway shows:** Here's an up-to-the-minute guide to all Broadway shows—musicals, dramas, comedies and those that are kid-friendly. www.nycgo.com/broadway/?cid=nycgov_bway_101309
- **Empire State Building:** Soaring more than a quarter of a mile above the heart of Manhattan, the Empire State Building is the world's most famous office building. www.esbnyc.com
- **Madison Square Garden:** See the schedule of events, purchase tickets and find out what's in and around the Garden before you visit. www.thegarden.com
- **Radio City Music Hall:** Radio City presents and promotes the best in live entertainment, including the famous Radio City Rockettes. www.radiocity.com
- **Statue of Liberty:** "Liberty Enlightening the World" was a gift of friendship from the people of France to the United States and is a universal symbol of freedom

and democracy. www.nps.gov/stli/index.htm

- **Times Square:** An electric hub of urban energy. Learn all Times Square has to offer at www.timessquarenyc.org/index.aspx.

Top Restaurants

New York City is often considered the culinary capital of America. While at Vision Expo East, make a reservation at one of Yelp's top 10 eating spots:

- **Eleven Madison Park:** 11 Madison Ave., <http://elevenmadisonpark.com/>
- **Le Bernardin:** 155 W. 51st St., <http://le-bernardin.com/>
- **Gramercy Tavern:** 42 E. 20th St., www.gramercy-tavern.com/
- **Ilili:** 236 5th Ave., www.ililinc.com/
- **Pylos:** 128 E. 7th St., www.pylosrestaurant.com/
- **Gotham Bar and Grill:** 12 E. 12th St., <http://gotham-barandgrill.com/>
- **Traif:** 229 S. 4th St., www.traifny.com/
- **Morimoto:** 88 10th St., www.morimotonyc.com/
- **SriPraPhai:** 6413 39th Ave., Woodside, www.sri-praphairestaurant.com/
- **Bouley:** 163 Duane St., www.davidbouley.com/

(continued from page 20)

Mar. 22-23, Fort Myers, FL Ft. Myers Spring Conference

HOST: Nova Southeastern University
KEY FACULTY: Kim Reed, Steve Ferrucci
CE HOURS: 11
LOCATION: Nova Southeastern University, 3650 Colonial Court
CONTACT: Vanessa McDonald
oceaa@nova.edu
954-262-4224
<http://optometry.nova.edu/ce/index.html>
NT SD

Mar. 26-30, New York City Vision Expo East

HOST: International Vision Expo and Conference
CE HOURS: 325+
LOCATION: Jacob Javits Center, 655 W 34th Street
CONTACT:
www.visionexpoeast.com
AL AM BV CM CL CD CS CT DB DE EL GL NO NT IN DS PE PH PM RE RS SD UV VT

Mar. 27-29, Norman, OK OAOP Annual Spring Congress

HOST: Oklahoma Association of Optometric Physicians
KEY FACULTY: Walt West, Blair Lonsberry, David Talley, Larry Henry,

Jason Ellen, Chad Chamberlain, Joyce Ardrey
CE HOURS: 18
LOCATION: Embassy Suites Hotel & Conference Center 2501 Conference Drive
CONTACT: Heatherlyn Burton
heatherlyn@oaop.org
405-524-1075
www.oaop.org
CM CL IN PH PM RS

Mar. 27-30, Memphis VT/Strabismus & Amblyopia

HOST: Optometric Extension Program Foundation (OEP)
KEY FACULTY: Paul A. Harris
CE HOURS: 28
LOCATION: Southern College of Optometry, 1245 Madison Avenue
CONTACT: Karen Ruder
Karen.Ruder@verizon.net
410-561-3791
www.oepf.org
AM BV VT

Mar. 29-30, Niagra Falls, NY Conference on Comprehensive EyeCare

HOST: PSS EyeCare
KEY FACULTY: Joseph Sowka, Paul Ajamian, Deepak Gupta, Anthony Litwak
CE HOURS: 18
LOCATION: Sheraton Hotel,

300 3rd Street
CONTACT: Sonia Kumari
education@psseyecare.com
203-415-3087

www.psseyecare.com

AL AM CM CL CD CS CT DB DE EL GL NT IN PH PM RE RS SD UV

Mar. 29-30, Bloomington, IN 2nd Annual Borish Symposium

HOST: Indiana University
CE HOURS: 12
LOCATION: Indiana University School of Optometry, 800 E. Atwater St.
CONTACT: Cheryl Oldfield
coldfiel@indiana.edu
812-856-3502
www.opt.indiana.edu/ce/Seminars.htm

Mar. 30, New York City Spring 2014 Educational Symposium

HOST: Ocular Nutrition Society in conjunction with Vision Expo East
KEY FACULTY: Johanna Seddon, Dorothy Hitchmoth, Elizabeth Johnson, Michael Cooney, Randy Hammond
CE HOURS: 6
LOCATION: Jacob Javits Center, 655 W. 34th Street
CONTACT: Jeffrey Anshel
ocularnutritionociety@gmail.com
800-383-1202
www.ocularnutritionociety.org
NT

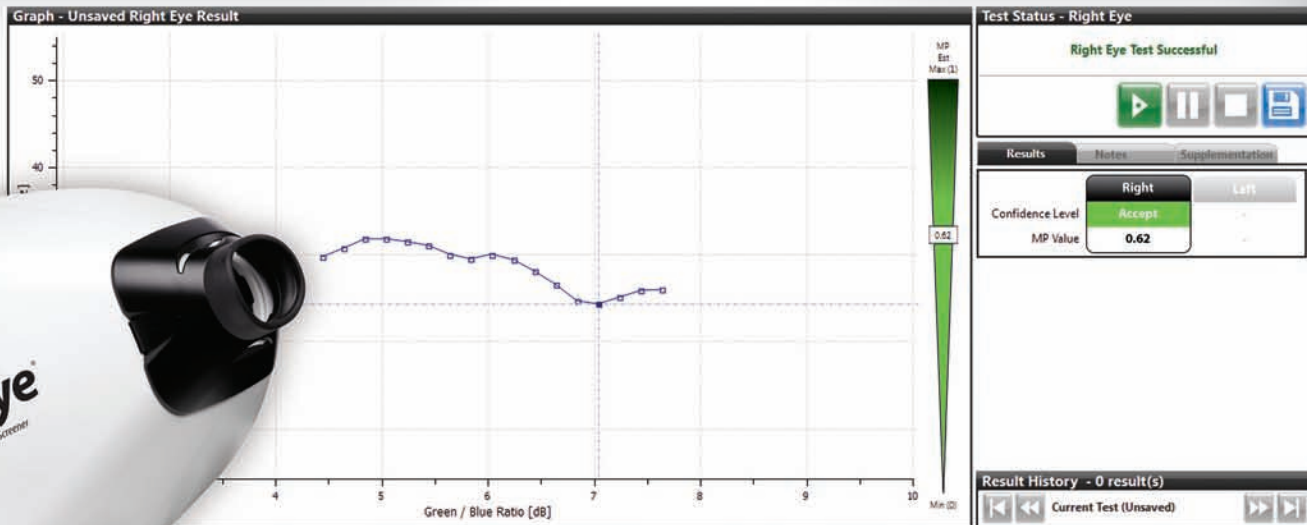

New DQI provides automated graph quality based on a familiar Green-Yellow-Red scale.

The NEXT GENERATION in Macular Pigment Measurement:

QuantifEye[®] MPS II

Since 2006, the original *QuantifEye* macular pigment measurement instrument has been the industry standard backed by science with more than 4-million eyes accurately measured.

The new *QuantifEye* MPS II offers significant software enhancements including:

- ~ Unsurpassed technician usability with a new Data Quality Index (DQI)
- ~ Significantly faster time in the lane with enhanced features and user-interface
- ~ Intuitive workflow with multiple reports

Request a demo and special introductory pricing by visiting www.quantifeye.com/mps2

(866) 833-2800 | support@zeavision.com

Right
Accept
0.62

Right
Caution
0.24

Right
Reject
-

April

Sunday	Monday	Tuesday	Wednesday	Thursday	Friday	Saturday
		1	2	3	4	5
					<ul style="list-style-type: none"> • OptoWest 2014 • NOA Spring Conference • Retina Update 2014 • Nutrition & the Eye Symposium VII 	
6	7	8	9	10	11	12
<ul style="list-style-type: none"> • OptoWest 2014 • NOA Spring Conference • Retina Update 2014 • Nutrition & the Eye Symposium VII 					<ul style="list-style-type: none"> • New Mexico Opt. Assn. Annual Convention • RSO Spring Seminar 2014 • Symposium on Ocular Disease • CE Seminar and Optifair Canada 	
13	14	15	16	17	18	19
<ul style="list-style-type: none"> • New Mexico Opt. Assn. Convention • RSO Spring Seminar 2014 • Symposium on Ocular Disease • CE and Optifair • Cornea & Contact Lens CE 		<ul style="list-style-type: none"> • Sacramento Valley Opt. Society 	<ul style="list-style-type: none"> • Wisconsin Opt. Assn. Spring Seminar 			
20	21	22	23	24	25	26
					<ul style="list-style-type: none"> • VT/Visual Dysfunctions • AAO New Jersey Chapter • Contact Lens Society of America • MWCO Annual Congress • KOA 2014 Spring Congress • Midwestern Univ. Resident's Day • Optometric Society Annual Symposium • Energieyes National Meeting • Indiana Optometry Convention • ASCRS IOMED 	
27	28	29	30			
<ul style="list-style-type: none"> • VT/Visual Dysfunctions • AAO New Jersey • KOA 2014 Spring Congress • Optometric Society Annual Symposium • Energieyes Nat. Mtg. • Indiana Optometry Convention • ASCRS/ASOA IOMED Program 			<ul style="list-style-type: none"> • Montana Opt. Assn. Annual Conference 			

Apr. 3-6, Indian Wells, CA OptoWest 2014

HOST: California Optometric Association
 KEY FACULTY: Marc Bloomenstein, Sharon Carter, Melissa Chun, Laurie Guest, Lynn Hellerstein, Richard Hom
 CE HOURS: 40+
 LOCATION: Esmeralda Hotel, 44-400 Indian Wells Lane
 CONTACT: Rachael Van Cleave

contact@coavision.org
 916-441-3990
www.coavision.org/i4a/pages/index.cfm?pageid=3301
 CL CS DE GL NT IN PE PH PM SD

Apr. 4-6, Omaha, NE NOA Spring Conference

HOST: Nebraska Optometric Association
 CE HOURS: 16

LOCATION: Embassy Suites Downtown/Old Market, 555 S. 10th Street
 CONTACT: Alissa Johnson
 402-474-7716
nebraska.aoa.org/springconference

Apr. 4-6, Boston Retina Update 2014

HOST: Optometric Retina Society and Review of Optometry
 KEY FACULTY: Joseph Pizzimenti

(ORS President), Leo Semes, Mark Dunbar, Brad Sutton, Clement Trempe
CE HOURS: 15

LOCATION: Hyatt Regency Boston,
1 Avenue De Lafayette

CONTACT: Lois DiDomenico
reviewmeetings@jobson.com

866-658-1772

www.revoptom.com/ORSRetUpdate

RE

Apr. 5-6, St. Louis

Nutrition & the Eye Symposium VII

HOST: University of MO-St. Louis
College of Optometry

KEY FACULTY: Emily Cher, Ann Hoscheit, Elizabeth Johnson, Stuart Richer

CE HOURS: 12

LOCATION: UMSL-College of
Optometry, One University Blvd.

CONTACT: Lis Ellerbusch

ellerbusch@umsl.edu

314-516-5615

Optometry.umsl.edu

NT

Apr. 11-13, Albuquerque, NM

Optometric Assn. Annual Convention

HOST: New Mexico Optometric
Association

CE HOURS: 22

LOCATION: Isleta Resort, 11000
Broadway SE

CONTACT: Richard Montoya

newmexicooptometry@gmail.com

575-751-7242

www.newmexicooptometry.org

Apr. 12-13, San Antonio

RSO Spring Seminar 2014

HOST: Rosenberg School of Optom-
etry

KEY FACULTY: Blair Lonsberry, Mile
Bruijic, Jeff Rabin, Carolyn Majcher,
Chidinma Odoemenem

CE HOURS: 16

LOCATION: Rosenberg School of
Optometry, 9725 Datapoint St.

CONTACT: Sandra Fortenberry

rsocce@uiwtx.edu

210-283-6856

www.optometry.uiw.edu/continuing

CL CD GL IN RE

Apr. 12-13, Tyson's Corner, VA Symposium on Ocular Disease

HOST: PSS EyeCare

KEY FACULTY: Joseph Sowka, Murray
Fingeret, Deepak Gupta

CE HOURS: 18

LOCATION: Crowne Plaza Hotel,
1960 Chain Bridge Road

CONTACT: Sonia Kumari

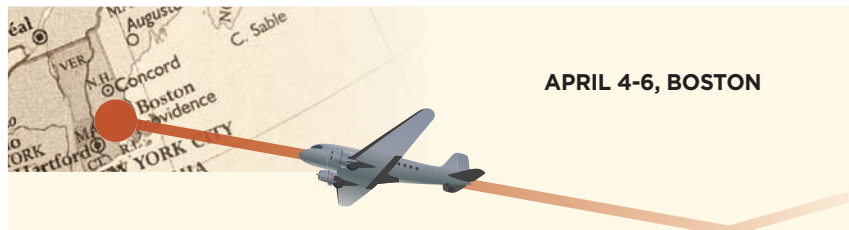

APRIL 4-6, BOSTON

Retina Update 2014 from the ORS

At the annual meeting of the
Optometric Retina Society (ORS),
held in conjunction with **Review of
Optometry** April 4-6 in Boston, a
panel of experts will present the lat-
est clinical updates in retinal disease
care. Attendees will be able to earn
15 hours of CE credit.

"This unique, comprehensive
program focuses on current and
future diagnostic and management
strategies for posterior segment dis-
eases," says ORS President Joseph
Pizzimenti, OD. "The primary eye
care clinician will come away with
valuable, clinically relevant informa-
tion that can be used immediately in
everyday practice."

Featured speakers are optom-
etrists Leo Semes, Mark Dunbar and
Brad Sutton, in addition to ophthal-
mologist Clement Trempe. Presenta-
tions include:

- The ABCs of Retinal Disease
- What's New in Retinal Imaging?

- Nutrition and Genetics in Retinal Health
- Holy Macula! The Vitreoretinal Interface
- Optometric Retina Society: Choroid Chronicles
- Retinal Vascular Disease Update
- Tales From the Trenches
- Not Your Grandpa's Low Vision Course
- The Posterior Segment in Diabetes
- Treatment and Comanagement of Retinal Disease

Dr. Pizzimenti says the meeting
will appeal to both general op-
tometrists looking to improve their
understanding of retinal disease and
to those with a particular interest in
retina who'll be looking for cutting-
edge topics and education.

For more information or to reg-
ister, contact Lois DiDomenico at
reviewmeetings@jobson.com or go
to [www.revoptom.com/ORSRet-
Update](http://www.revoptom.com/ORSRet-Update).



education@psseyecare.com

203-415-3087

www.psseyecare.com

AL AM CM CL CD CS CT DB DE EL GL NO

NT IN PH PM RE RS SD UV

Apr. 12-13, Brampton, Ontario Continuing Education Seminar and Optifair Canada Trade Show

HOST: The Academy of Ophthalmic
Education (AOE)



APRIL 24-26, SAVANNAH

CLSA 59th Annual Meeting

It's estimated that 36 million Americans wear contact lenses. From the continued evolution of daily disposables to clinical breakthroughs in improving conditions such as keratoconus through collagen cross-linking, it is essential for their doctors to keep up to date.

With this in mind, the 59th Annual Education Meeting of the Contact Lens Society of America (CLSA) will offer the latest information on contact lenses and clinical research during its meeting, scheduled from April 24-26 at the Hilton Savannah DeSoto in Savannah, GA. Attendees will be able to earn up to 22 hours of CE credit.

"The Contact Lens Society of America Annual Education Meeting offers something for everyone interested in the contact lens field,"

says CLSA education chair Michael A. Ward, MMSc, FAAO, FCLSA. "The CLSA program offers a full spectrum of education, including a 'Contact Lens Bootcamp' for those eager to learn the basics of lens fitting and dispensing, along with a wide range of advanced topics such as new lens technologies, scleral lens fitting, custom soft lens design and myopia control. I encourage all who are interested in contact lenses to attend the CLSA meeting to realize the potentials of current contact lens technologies."

Featured speakers include Patrick Caroline, OD, Craig Norman, FCLSA, Michael Ward, FCLSA, Jason Jedlicka, OD, Brooke Messer, OD, Edward Bennett, OD, and Stephen Byrnes, OD. For more information or to register, go to www.clsa.info.

KEY FACULTY: Robert A. Hohendorf
 CE HOURS: 35
 LOCATION: Vision and Sensory Center
 4467 Byron Center Rd., SW Building 3
 CONTACT: Karen Ruder
Karen.Ruder@verizon.net
 410-561-3791
www.oepf.org
BV VT

Apr. 23-27, Myrtle Beach, SC American Academy of Optometry New Jersey Chapter

HOST: AAO New Jersey Chapter
 KEY FACULTY: Randall Thomas, Ron Melton, Marc Bloomenstein
 CE HOURS: 16
 LOCATION: Kingston Plantation,
 Queensway Boulevard
 CONTACT: Dennis Lyons
dhl2020@aol.com
 732-920-0110
CD DE EL GL NO IN PH RE SD

Apr. 24-26, Savannah 59th Annual Education Meeting

HOST: Contact Lens Society of America
 KEY FACULTY: Patrick Caroline, Craig Norman, Michael Ward, Jason Jedlicka, Brooke Messer, Edward Bennett, Stephen Byrnes
 CE HOURS: 22
 LOCATION: Hilton Savannah DeSoto,
 15 East Liberty Street
 CONTACT: Tina Schott
tinaschott@clsa.info
 703-437-5100 www.clsa.info
CL CD DE NT PM

Apr. 24-26, Las Vegas MWCO Annual Congress

HOST: Mountain West Council of Optometry
 KEY FACULTY: Robert Wooldridge, Mark Dunbar, Rich Madonna, John McGreal, Bruce Onofrey
 CE HOURS: 24
 LOCATION: Caesars Palace 3570 Las Vegas Blvd.
 CONTACT: Tracy Abel
tracyabel@earthlink.net
 888-376-6926
www.mwco.org
CL CD DE GL IN PH PM RE RS SD

Apr. 24-27, Lexington, KY KOA 2014 Spring Congress

HOST: Kentucky Optometric Association
 CE HOURS: 21

KEY FACULTY: Carlo Pelino, Joseph Pizzimenti
 CE HOURS: 14
 LOCATION: Embassy Grand Convention Centre, 8800 The Gore Road
 CONTACT: Claudia Marks
cmarks@aoecea.com
 905-731-6022
www.aoecea.com
DB GL IN PH RE SD

Apr. 13, Fullerton, CA Annual Cornea & Contact Lens CE Program

HOST: SCCO at Ketchum University
 KEY FACULTY: Timothy Edrington, Jared Jaynes, Harue Marsden, Barry Weissman
 CE HOURS: 8
 LOCATION: Marshall B. Ketchum University, 2575 Yorba Linda Blvd.
 CONTACT: Antoinette & Bonnie
ce@ketchum.edu
 714-449-7495
www.ketchum.edu/ce
AL CL CS DE IN SD

Apr. 15, TBD, CA Sacramento Valley Optometric Society General Meeting

HOST: Sacramento Valley Optometric Society
 CE HOURS: 2
 CONTACT: Jerry Sue Hooper
jerrysue13@comcast.net
 916-447-0270

Apr. 16-17, Oconomowoc, WI Wisconsin Optometric Association Spring Seminar

HOST: Wisconsin Optometric Association
 KEY FACULTY: Danica Marelli, Stuart Richer, Leonard Messner
 CE HOURS: 14
 LOCATION: Olympia Resort
 CONTACT: Joleen Breunig
joleen@woa-eyes.org
 608-824-2200
www.woa-eyes.org
GL NO NT PH

Apr. 21-28, Grand Rapids, MI VT/Visual Dysfunctions

HOST: Optometric Extension Program Foundation (OEP)

One Plug One Size

SnugPlug™

That's *all* you need!

One-size-fits-all punctum plug
eliminates sizing and **simplifies stocking**

Pre-stretched shape (on inserter)
avoids dilation and **facilitates insertion**

Expanded shape (once inserted)
assures snug fit and **virtually
eliminates pop-out**

Soft collar prevents migration
and **provides patient comfort**



FCI-Ophthalmics.com
800.932.4202



Plug into FCI for Dry Eye Treatment and
watch the SnugPlug insertion video.

Visit **PlugintoFCI.com** for promotional pricing

LOCATION: 401 West High Street,
Hyatt Hotel & Lexington Convention
Center
CONTACT: Sarah Unger
sarah@kveves.org
502-875-3516 www.kveves.org

Apr. 25, Glendale, AZ
**Midwestern University 2nd Annual
Resident's Day Disease Symposium**

HOST: Midwestern University College
of Optometry
KEY FACULTY: Residents of the VA,
Indian Health Service and Tribal Health
Services from across the Southwest
CE HOURS: 3
LOCATION: Midwestern University,
College of Optometry,
19555 N. 59th Ave.
CONTACT: Kevin Helmuth
khelmu@midwestern.edu
623-806-7227
CD EL IN

Apr. 25-27, Chicago
2014 Annual CE Symposium

HOST: The Optometric Society and
Optometric CE
KEY FACULTY: James Fanelli, Ernie
Bowling, Robert Rebello, Steven New-
man
CE HOURS: 14
LOCATION: Renaissance O'Hare,
8500 West Bryn Mawr Avenue
CONTACT: Joel Rothschild
admin@optometricce.org
(909) 255-0464
www.optometricce.org
DB GL NO NT PH PM RE SD

Apr. 25-27, Colorado Springs
Energieyes National Meeting

HOST: Energieyes Association
KEY FACULTY: Eric Botts, Kerry Head,
Philip Haiman, Richard Hom, Joseph
Pizzimenti, Diana Shechtman, Jeff
Gerson
CE HOURS: 28
LOCATION: Cheyenne Mountain
Resort
CONTACT: Michael Porat
info@energieyesassociation.com
347-618-0784
www.energieyesassociation.com
CM DE GL NT IN RE

Apr. 25-27, Indianapolis
Indiana Optometry Convention

HOST: Indiana Optometric Association



**MWCO Meeting Offers 24 Hours
of CE at Caesars Palace**

Optometrists will have the opportunity to earn 24 hours of continuing education credit over three days—fulfilling total annual CE requirements for many—during the 2014 Mountain West Council of Optometrists' Annual Congress. The meeting will be held in Las Vegas at the legendary Caesars Palace Hotel from April 24-26.

"This year's congress provides a broad-based educational program to better enable our attendees to provide exceptional care for their patients for many years to come," says optometrist Robert Wooldridge, MWCO education chair.

The meeting will feature several leading speakers on the lecture circuit who will cover a wide variety of clinical topics.

Margie Recalde, OD, will provide updates on anterior and posterior segment diseases such as Demodex blepharitis, dry eye and Sjögren's syndrome.

Optometrist Mark Dunbar will

present on new treatments for AMD.

Attendees can learn more about contact lenses and corneal concerns at lectures by Drs. Melissa Barnett and Carl Spear.

Drs. Richard Madonna, John McSoley and Wooldridge will be speaking on diagnosis and management of glaucoma, including the latest updates on instrumentation and medical and surgical treatments. How to use and interpret OCT findings in glaucoma and retinal diseases will also be covered in detail.

Kim Reed, OD, will address the impact of obesity and other systemic health issues in patients and the most important nutritional supplements in their care.

Bruce Onofrey, OD, RPh, will also review nutraceuticals in eye care along with management of ocular infections and other emergencies.

Always a crowd favorite, John McGreal, OD, will review the latest trends in contemporary medicine and give an introduction to the new ICD-10 coding system.

For more information or to register, go to <http://www.mwco.org/>.

KEY FACULTY: Ron Melton, Randall Thomas, Denise Goodwin, Larry Koval, James Hunter, Victor Malinovsky, Ben Gaddie, Mile Brujic
CE HOURS: 17

LOCATION: Sheraton Keystone at the Crossing, 8787 Keystone Crossing
CONTACT: Bridget Sims
blsims@ioa.org
315-237-3560
www.ioa.org
CL CT GL NO IN PH RE

Apr. 26-28, Boston
**ASCRS/ASOA Symposium &
Congress IOMED Program**

CE HOURS: 15 (approval pending)
LOCATION: Boston Convention and Exhibition Center (BCEC),
415 Summer Street
CONTACT: Paula Cooke
pcooke@ascrs.org

703-591-2220
<http://annualmeeting.ascrs.org/iomed-program-highlights>
CM CD DE IN PE PM

Apr. 30-May 2, Billings, MT
**MOA 2014 Annual Educational
Conference & Exposition**

HOST: Montana Optometric Association
KEY FACULTY: Mile Brujic, Derek Cunningham, Robert Wooldridge, Joe Ellis, Ian McWherter
CE HOURS: 18
LOCATION: Holiday Inn Grand Montana, 5500 Midland Road
CONTACT: Sue Weingartner
sweingartner@rmsmanagement.com
406-443-1160
www.mteyes.com
CL CD GL PH RE SD



ANATOMY OF A GREAT EXAM LANE

Quality or Value - go ahead you can have both

S4OPTIK products are the perfect blend of extraordinary Value and Quality. Instruments which satisfy even the most discerning practitioner.

H + Z SERIES SLIT LAMPS

Z-SERIES

Compact Illumination Models



H-SERIES

Vertical Illumination Models

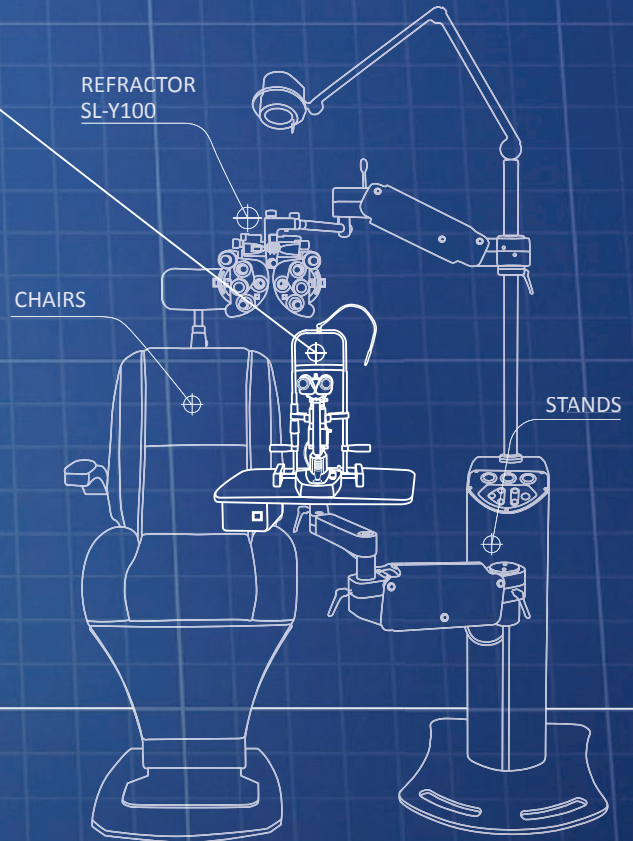

SLIT LAMP FEATURES

- Multilayered anti-reflective coatings
- Stunning optical quality allowing clear visualization and depth of field
- 20% increase in optical transmission
- 10% increase to the depth of field

www.s4optik.com | info@s4optik.com



5325 Cleveland Street, Suite 303.
Virginia Beach, VA 23462
T: 1.888.224.6012 | www.s4optik.com



May

Sunday	Monday	Tuesday	Wednesday	Thursday	Friday	Saturday
				1	2	3
					• AAO Florida Chapter • CE in Italy • New Technologies and Treatments in Vision Care • Nova Annual Conference & Alumni Reunion • UC Berkeley Morgan Symposium	
4	5	6	7	8	9	10
• CE in Italy • New Technologies and Treatments • Nova Annual Conf. & Alumni Reunion • UC Berkeley Morgan Symposium • SCCO Glaucoma Grand Rounds			• Michigan Opt. Assn. Annual Meeting		• 2014 Coeur d'Alene CE	• Mediterranean Cruise Seminar
		• ARVO Annual Meeting				
11	12	13	14	15	16	17
			• CE in Italy/Austria • Traumatic/Acquired Brain Injury			
	• Mediterranean Cruise Seminar					
18	19	20	21	22	23	24
• Traumatic/Acquired Brain Injury • CE in Italy/Austria • Mediterranean Cruise Seminar		• Sacramento Valley Opt. Society				
25	26	27	28	29	30	31
				• Oregon's Meeting • Pearls in Ocular Diagnosis		

**May 2-3, Howey-In-The-Hills, FL
American Academy of Optometry
Florida Chapter**

HOST: AAO Florida Chapter
KEY FACULTY: Albert Woods, Tim Underhill, Leo Semes
CE HOURS: 10
LOCATION: Mission Inn, 10400 County Road 48
CONTACT: Arthur Young eyequy4123@msn.com
239-542-4627
GL PH RE

**May 2-4, Rome, Italy
CE in Italy**

HOST: James L. Fanelli

KEY FACULTY: Joe Pizzimenti, Carlo Pelino, James Fanelli
CE HOURS: 12
CONTACT: James Fanelli jamesfanelli@CEinItaly.com
910-452-7225
www.CEinItaly.com
EL GL NO PH RE SD

**May 2-4, La Jolla, CA
New Technologies and Treatments in
Vision Care - West Coast**

HOST: Review of Optometry
KEY FACULTY: Paul Karpecki, Jeffrey Gerson, Ron Melton, Randall Thomas
CE HOURS: 15
LOCATION: Hilton La Jolla Torrey

Pines, 10950 N. Torrey Pines Road
CONTACT: Lois DiDomenico
ReviewMeetings@Jobson.com
866-658-1772

AL CM CL CD DE EL GL NT IN PH RE SD

**May 2-4, Fort Lauderdale
May Annual Eye Care Conference &
Alumni Reunion**

HOST: Nova Southeastern University
KEY FACULTY: Carl Pelino
CE HOURS: 18
LOCATION: Nova Southeastern University, 3200 S. University Drive
CONTACT: Vanessa McDonald oceaa@nova.edu
954-262-4224

<http://optometry.nova.edu/ce/index.html>

BV CL IN SD

May 2-4, Berkeley, CA

Morgan Symposium, 29th Annual

HOST: University of California, Berkeley School of Optometry
CE HOURS: 21

LOCATION DoubleTree Hotel, Berkeley Marina, 200 Marina Blvd.

CONTACT: Danni Peck
optoce@berkeley.edu
800.827.2163

<http://optometry.berkeley.edu/ce/morgan-symposium>

CM CD DB DE EL GL NO IN PH RE SD

May 4-5, Fullerton, CA

Glaucoma Grand Rounds

HOST: SCCO at Ketchum University
KEY FACULTY: George Comer, John Nishimoto, Mark Sawamura, Judy Tong, Robert Yacoub
CE HOURS: 16

LOCATION Marshall B. Ketchum University, 2575 Yorba Linda Blvd.
CONTACT: Antoinette & Bonnie

ce@ketchum.edu

714-449-7495

www.ketchum.edu/ce

GL

May 4-8, Orlando

ARVO Annual Meeting

HOST: ARVO

LOCATION: Orange County Convention Center

South Concourse, South Building, 9899 International Drive
CONTACT: arvo@arvo.org
240-221-2900

www.arvo.org/

AL AM BV CM CL CD CS CT DB DE EL GL
NO NT IN DS PE PH PM RE RS SD UV VT

May 7-8, Grand Rapids, MI

Michigan Optometric Assn. 118th Annual Meeting and Spring Seminar

HOST: Michigan Optometric Association

CE HOURS: 12

LOCATION: DeVos Place, 303 Monroe Ave NW

CONTACT: Amy Root
amy@themoa.org
517-482-0616

www.themoa.org

May 9-10, Coeur d'Alene, ID 2014 Coeur d'Alene CE

HOST: Pacific University
KEY FACULTY: Ami Halvorson, Kirk

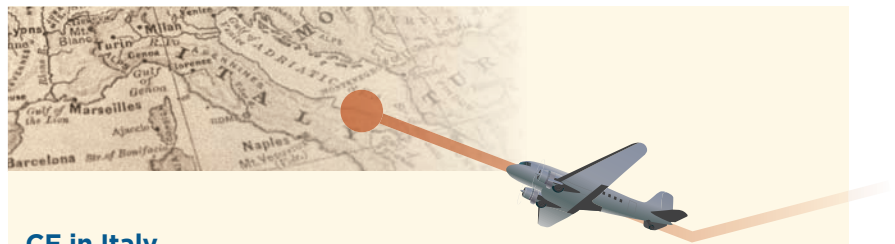

CE in Italy

Optometric CE opportunities aren't just restricted to US venues. In recent years, they've gone global. The CE in Italy meeting series offers optometrists the chance to gain continuing education credits at courses presented by esteemed doctors in some of the most beautiful locations in the world.

"One of the things that makes this conference so appealing is the fact that it's a great venue, whether it is one's first trip to Italy or tenth," says conference host James Fanelli, OD. The spring and fall session locations are carefully selected, including popular cities such as Rome, Florence and Venice for the first-time traveler, and more unique spots such as the Italian Alps and a small hilltop village in Tuscany for the seasoned visitor looking to sight-see off the beaten path.

The CE program begins early in the mornings and finishes early as well. "There are no afternoon sessions," Dr. Fanelli says, "so, once the day's continuing education is complete, the participants are free to explore or relax for the entire day and don't have to be back in class

until the next morning." In addition to organizing the educational program, Dr. Fanelli provides advice on hotels, driving itineraries, tourist attractions and even "local restaurants and specialty dishes, wineries and olive oil producers."

The spring and fall meetings will have separate educational components consisting of 12 CE credits each. Doctors can register for either program for one fee, or both programs in either the spring or fall at a reduced rate.

To register, or to get more information on the meeting or hotels, go to www.CEinItaly.com.

The CE in Italy meeting dates and locations are:

- **SPRING 2014 MEETINGS:**

- Rome, Italy — May 2-4

- Vienna, Austria — May 14-17

- Salzburg, Austria — May 18-20

- **FALL 2014 MEETINGS:**

- Rome, Italy — Sept. 21-23

- Florence, Italy — Sept. 25-27

- Castiglion Fiorentino, Italy —

- Sept. 28-30

Halvorson, Tad Buckingham

CE HOURS: 10

LOCATION The Coeur d'Alene Resort, 115 S. 2nd Street

CONTACT: Jeanne Oliver

jeanne@pacificu.edu

503-352-2740

www.pacificu.edu/optometry/ce/conferences_events.cfm

IN RE SD

May 10-19, Athens to Venice Mediterranean Cruise Seminar

HOST: AEA Cruises

KEY FACULTY: Louise Sclafani, Mark Roanova

CE HOURS: 10

LOCATION: Silversea Silver Wind

CONTACT: Marge McGrath

aeacruises@aol.com

773-594-9866; 888-638-6009

www.optometriccruiseseminars.com

May 14-17, Vienna, Austria CE in Italy

HOST: James L. Fanelli

KEY FACULTY: Joseph Pizzimenti, James Fanelli

CE HOURS: 12

CONTACT: James Fanelli

jamesfanelli@CEinItaly.com

910-452-7225

www.CEinItaly.com

EL GL NO PH RE SD

May 15-18, Memphis Traumatic Brain Injury/Acquired Brain Injury

HOST: Optometric Extension Program Foundation (OEP)

KEY FACULTY: Paul A. Harris
 CE HOURS: 21
 LOCATION Southern College of
 Optometry, 1245 Madison Ave.
 CONTACT: Karen Ruder
Karen.Ruder@verizon.net
 410-561-3791
www.oepf.org

AM

**May 18-20, Salzburg, Austria
 CE In Italy**

HOST: James L. Fanelli
 KEY FACULTY: Joseph Pizzimenti,
 James Fanelli
 CE HOURS: 12
 CONTACT: James Fanelli
jamesfanelli@CEinItaly.com
 910-452-7225
www.CEinItaly.com

CD EL GL NO RE UV

**May 20, TBD, CA
 Sacramento Valley Optometric
 Society General Meeting**

HOST: Sacramento Valley Optometric
 Society
 CE HOURS: 2
 CONTACT: Jerry Sue Hooper
jerrysue13@comcast.net
 916-447-0270

**May 29-31, Bend, OR
 Oregon's Meeting**

HOST: Oregon Optometric Physicians
 Association
 KEY FACULTY: Jane Weissman,
 Thomas Hwang, Greg Kautz, Ryan
 Bulson, Mark Andre
 CE HOURS: 11
 LOCATION: Bend Riverhouse Hotel &
 Conference Center,
 3075 U.S. 97 Business
 CONTACT: Lynne Olson
lynne@oregonoptometry.org
 800-922-2045
www.oregonoptometry.org

CL CD CS EL NO IN DS PM RE RS

**May 30-Jun. 1, San Francisco
 Ocular Symposium: Pearls in
 Ocular Diagnosis**

HOST: Ocular Symposium
 KEY FACULTY: Ophthalmologists
 on systemic disease, in numerous
 subspecialties
 CE HOURS: 24 (pending)
 LOCATION: Holiday Inn Golden Gate
 Way 1500 Van Ness Ave.
 CONTACT: Lorraine Geary
ocularsymp@aol.com
 415-278-9940

CD CS CT GL NO IN PE PH RE RS SD UV

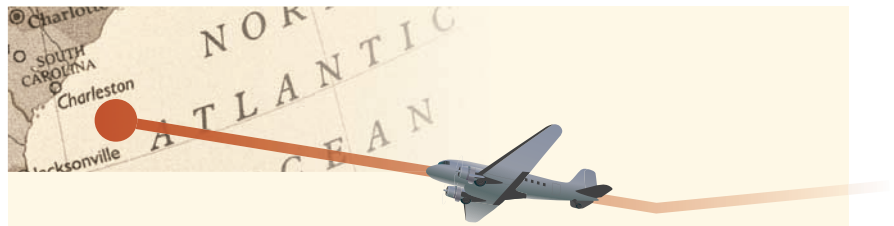

Melton & Thomas “2014 Tour Dates”

It’s not a stretch to consider op-
 tometrists Ron Melton and Randall
 Thomas to be rock stars on the lec-
 ture circuit. For years, the joint pre-
 sentations by these North Carolina
 natives have easily and consistently
 drawn some of the biggest crowds.
 Chalk it up to the unique combina-
 tion of their clinical prowess and
 highly original lecture style.

“All of our material is focused
 on presenting clinically relevant
 information in an enjoyable format of
 ‘team-teaching,’ which we pioneered
 over 25 years ago,” Dr. Thomas says.

The lecture content combines their
 decades of experience with a timely
 review of the scientific literature. “We
 draw from intensive clinical practice
 over our combined 65 years in the
 trenches. This clinical seasoning is
 augmented by our monthly perusal
 of several professional journals, and
 therefore we strive to make our
 teaching as up-to-date as possible.”

The goal, says Dr. Thomas, “is to
 help every optometric physician
 practice in a highly competent, com-
 prehensive manner.”

*The always-in-demand duo have many commitments scheduled in 2014—
 and more will be added throughout the year. Here’s a list of their confirmed
 appearances known at press time:*

Date	Location	Conference	For More Info
Jan. 5	New York	Eye to Eye	www.revoptom.com/continuing_education
Jan. 18-23	Costa Rica	Tropical CE	https://tropicalce.com
Feb. 1	Windsor, Ontario	University of Windsor CE Seminar	www.aoece.com
Mar. 8	St. Louis	Eye to Eye	www.revoptom.com/continuing_education
Mar. 9	Pittsburgh	Western PA Opt. Soc. CE	www.wpos.org
Mar. 15	Atlanta	SECO	http://seco2014.com
Mar. 22-23	West Coast	Eye to Eye	www.revoptom.com/continuing_education
Mar. 29-30	New York	Vision Expo East	www.visionexpoeast.com
Apr. 4-5	Birmingham, AL	University of Alabama CE	http://www.uab.edu
Apr. 23-24	Myrtle Beach, SC	New Jersey chapter of AAO CE	www.aaopt.org/about/chapters
Apr. 25	Indianapolis	Ind. Opt. Assn. Annual Meeting	www.ioa.org
Apr. 26	Little Rock, AK	ArOA Spring Convention	www.arkansasoptometric.org
Apr. 27	Moncton, New Brunswick	Maritime Provinces Assn. of Opt.	www.nsoptometrists.ca
May 3	San Diego	New Technologies and Treatments	www.revoptom.com/continuing_education
Jun. 21	Baton Rouge, LA	LA Opt. Assn. 100th Anniversary	www.optla.org
Jun. 28	Philadelphia	AOA Annual Meeting	www.aoa.org
Sept. 20	Las Vegas	Vision Expo West	www.visionexpowest.com
Sept. 21	Torrance, CA	South Bay Opt. Society	www.southbayoptometricsociety.com
Oct. 11	Cleveland	EastWest Eye	www.eastwesteye.org/aws/OOA/pt/sp/home_eastwestconf
Oct. 12	Orlando	Forum on Ocular Disease	www.psseyecare.com/Pages/default.aspx
Oct. 30-31	Trinidad & Tobago	Trinidad/Tobago Opt. Society	ttopom.tripod.com
Nov. 7-8	Montreal	Quebec Assn. of Optometrists	www.aoqnet.qc.ca

All new exam lane packages are here.



**STARTING
FROM JUST
\$12,998**

Rent or lease programs also available.

Including:

- ✓ HAI SL-5000 Slit Lamp
- ✓ S4Optik Chair, Stand & Refractor
- ✓ Righton Chart Projector & Screen

Add-Ons & Upgrades Available:

- ✓ S4Optik Chair Glide for Wheelchairs
- ✓ HAI Digital Video Camera for Slit Lamp & CL-1000eva Specular Attachment



Brought to you by the experienced team behind HAI Labs, **HAI Ophthalmic** is your new one-stop shop to rent, lease or buy premium exam lane and diagnostic equipment from brands you know and trust, without the hefty price tags. Get in touch today to learn more!

*Slit lamps • Specular microscopes • Corneal topographers • Keratometers • Ultrasounds
Vision charts and testers • Autorefractors • Lensmeters • Pachymeters • Tonometers
Trial lens sets • Chairs and stands • Digital imaging solutions*



Call (781) 862-9884 or e-mail sales@hailabs.com for details.

June

Sunday	Monday	Tuesday	Wednesday	Thursday	Friday	Saturday
1	2	3	4	5	6	7
	• SCCO Indian Health Service CE Program			• Art & Science of Optometric Care - A Behavioral Perspective		• British Contact Lens Association Clinical Conference
						• Everything Therapeutic Symposium • Cornea and Contact Lens Symposium
8	9	10	11	12	13	14
• Art & Science of Optometric Care - A Behavioral Perspective • BCLA Clinical Conference					• Northwest Residents Conference	
• Everything Therapeutic Symposium • Cornea and Contact Lens Symposium • UC Berkeley Resident Forum					• NCOS Spring Congress	
15	16	17	18	19	20	21
• NCOS Spring Congress				• New Technologies and Treatments in Vision Care		
					• Opt. Assn. of Louisiana Annual Convention • Virginia Opt. Assn. Annual Conference	
22	23	24	25	26	27	28
• New Technologies and Treatments in Vision Care • Opt. Assn. of Louisiana Annual Convention • Virginia Opt. Assn. Annual Conference			• AOA 2014 Optometry's Meeting			• American Conference on Pediatric Cortical Visual Impairment
29	30					
• AOA 2014		• Alaska Inside Passage Cruise Seminar				
• Tropical CE Bahamas						

Jun. 2-5, Fullerton, CA
Indian Health Service CE Program
 HOST: SCCO at Ketchum University
 KEY FACULTY: Anand Bhatt, Sue Cotter, Brett Larson, Blair Lonsberry, Mark Sawamura, Dave Sendrowski, Barry Weissman
 CE HOURS: 30
 LOCATION: Marshall B. Ketchum University, 2575 Yorba Linda Blvd.
 CONTACT: Antoinette & Bonnie ce@ketchum.edu

714-449-7495
www.ketchum.edu/ce
 AL AM CL CD CS DE GL NO IN PE PH SD

Jun. 5-9, Ft. Lauderdale
The Art & Science of Optometric Care - A Behavioral Perspective
 HOST: Optometric Extension Program Foundation
 KEY FACULTY: John Abbondanza
 CE HOURS: 35
 LOCATION: Nova Southeastern

College of Optometry,
 3200 South University Drive
 CONTACT: Karen Ruder
Karen.Ruder@verizon.net
 410-561-3791
www.oepf.org
 BV PE

Jun. 6-9, Birmingham, UK
38th British Contact Lens Association Clinical Conference & Exhibition
 HOST: British Contact Lens Assn.

KEY FACULTY: Phillip Morgan, Heiko Pult, Motozumi Itoi, Bruce Evan
 CE HOURS: 10
 LOCATION: International Convention Centre
 CONTACT: Sarah Greenwood
conf@bcla.org.uk
 44 0207 5806661
www.bcla.org.uk
CL CD CS DE DS PM

**Jun. 7-8, Houston
 Everything Therapeutic Symposium**

HOST: University of Houston College of Optometry
 CE HOURS: 16
 LOCATION: UHCO-HBSC, 4901 Calhoun Rd.
 CONTACT: Amanda Johnson
ajohnson@optometry.uh.edu
 713-743-1900
<http://ce.opt.uh.edu/>
PH

**Jun. 7-8, Bloomington, IN
 Cornea and Contact Lens Symposium**

HOST: Indiana University
 CE HOURS: 12
 LOCATION: Indiana University School of Optometry, 800 E. Atwater
 CONTACT: Cheryl Oldfield
coldfiel@indiana.edu
 812-856-3502
www.opt.indiana.edu/ce/Seminars.htm
CL CD

**Jun. 8, Berkeley, CA
 Resident Forum**

HOST: UC Berkeley School of Optometry
 KEY FACULTY: On-Campus and Affiliate VA Residents
 CE HOURS: 8
 LOCATION: UC Berkeley Campus, Room TBD, 200 Minor Hall
 CONTACT: Mika Moy
mmoy@berkeley.edu
 510-642-8802
<http://optometry.berkeley.edu/ce/introduction>

**Jun. 13-14, Forest Grove, OR
 Northwest Residents Conference**

HOST: Pacific University College of Optometry
 KEY FACULTY: Residents from affiliated programs in MN, OR, PA and WA
 CE HOURS: 10
 LOCATION: Jefferson Hall on Pacific University Campus, 2043 College Way
 CONTACT: Martina Fredericks
frederim@pacificu.edu
 503-352-2207



BCLA Annual Conference

“What Will You Take Away?” is the theme of the 38th British Contact Lens Association (BCLA) Clinical Conference & Exhibition, scheduled for June 6-9 at the International Convention Centre in Birmingham, UK. The BCLA has added new elements this year to ensure its delegates “take away” fresh skills and strategies to put into practice, including more hands-on workshops and a greater focus on everyday contact lens practice issues such as comfort, keratoconus and myopia control.

Keynote speakers include 2014 BCLA Medalist Philip Morgan, BSc, PhD, MCOptom (UK), who will present “Changing the World with Contact Lenses.” Dr. Heiko Pult, MSc, PhD (UK), will present the Irving Fatt Memorial Lecture, “Clinical Evalua-

tion of Dry Eye: A Year of Research.” Other keynote speakers: Lyndon Jones, BSc, PhD (Canada), Motozumi Itoi, MD, PhD (Japan), and Bruce Evans, BSc, PhD (UK).

There will be an enhanced program of CET workshops running for the four days of the conference, with some repeated to ensure as many delegates can attend as possible. Workshop topics will include IOLs, laser refractive surgery, scleral lenses, and dry eye assessment and management. Peer-review discussion groups, for which delegates must pre-register, will also take place each day, offering three CET points each.

For more information or to register, go to www.bcla.org.uk or contact Sarah Greenwood at conf@bcla.org.uk.

www.pacificu.edu/optometry/ce/conferences_events.cfm
BV CM CL CD GL NO PE SD

**Jun. 13-15, Myrtle Beach, SC
 NCOS Spring Congress**

HOST: North Carolina State Optometric Society
 CE HOURS: 18
 LOCATION: Embassy Suites Kingston Plantation, 9800 Queensway Blvd.
 CONTACT: Adrienne Drollette
adrienne@nceyes.org
 252-237-6197
www.nceyes.org

**Jun. 19-22, Orlando
 New Technologies and Treatments in Vision Care**

HOST: Review of Optometry
 KEY FACULTY: Paul Karpecki, Steve Ferrucci, Marc Bloomenstein, Doug Devries
 CE HOURS: 14
 LOCATION: Disney's Yacht & Beach Club, 1700 Epcot Resort Blvd.
 CONTACT: Lois DiDomenico
reviewmeetings@jobson.com
 866-658-1772
AL CD DE EL GL NT IN PH SD

**Jun. 20-22, Baton Rouge
 OAL 100th Anniversary
 Annual Convention**

HOST: Optometry Association of Louisiana
 KEY FACULTY: Larry Alexander, James Thimons, Randall Thomas, Ron Melton
 CE HOURS: 16
 LOCATION: Crowne Plaza Hotel, 4728 Constitution
 CONTACT: Jim Sanderfur
optla@bellsouth.net
 318-335-0675
www.optla.org
AL CD DB DE EL GL NO IN PH RE SD UV

**Jun. 20-22, Richmond, VA
 VOA Annual Conference**

HOST: Virginia Optometric Association
 CE HOURS: 15
 LOCATION: Omni Richmond Hotel, 100 S 12th St.
 CONTACT: Bruce Keeney
office@thevoa.org
 804-643-0309
www.thevoa.org

(continued on page 40)



JUNE 25-29, PHILADELPHIA

More Than 225 CE Hours Offered at Optometry's Meeting

Optometry's Meeting, sponsored by the American Optometric Association, is always a major draw for optometrists. This year, attendees will have the opportunity to take advantage of more than 225 hours of continuing education credit and an additional half-day of CE. The 2014 meeting will take place in Philadelphia from June 25-29, and the educational portion of the meeting will be extended from Wednesday, June 25, through Saturday, June 28. The meeting will be held in the Pennsylvania Convention Center in the heart of Philadelphia's downtown.

Olympic Gold medalist and cancer survivor Scott Hamilton—whose motto is “the only disability in life is a bad attitude”—has been invited to be the keynote speaker during the Wednesday opening general session, which is sponsored by Essilor.

The meeting will also offer “Product and Technology Exchange Sessions,” where companies will present their products or services. These sessions do not count toward CE credit. Attendees will receive a gift card or



a similar incentive for attendance.

In addition to ample CE and other educational opportunities, the meeting will feature 200-plus exhibits. Exhibit hall hours are: Thursday 4:00 pm – 7:30 pm, Friday 10:00 am – 5:00 pm and Saturday 9:30 am – 2:00 pm.

Optometry's Meeting 2014 will also host more than 50 special

events. The Celebration of Optometry (Presidential Celebration) will take place in the Philadelphia Convention Center ballroom Saturday evening; it is sponsored by Hoya. An Optometry Cares 5K run/walk will take place on Saturday morning.

Also new this year: the majority of the student program will be incorporated into the OD program, except for a few sponsored student courses and events. Additionally, the House of Delegates will meet all day Thursday, with no House of Delegates meeting on Friday. Saturday's House of Delegates schedule is expected to

remain the same as in previous years.

Registration and housing opens in February. The education, exhibit hall and most ballroom events will be located in the Pennsylvania Convention Center. House of Delegates, affiliate/miscellaneous meetings and alumni receptions will be located at the Marriott Downtown, Loews and Marriott Courtyard hotels.

For more information and to register, go to: www.optometrymeeting.org.

Much to Love in the City of Brotherly Love

While at the AOA meeting, take a few minutes and visit some of Philadelphia's many attractions:

- **Liberty Bell Center:** Independence Mall, 525 Market Street, www.nps.gov/inde/liberty-bell-center.htm

This 2,080-pound piece of history was once mounted in the belfry of Independence Hall. It was rung to mark important historic events, most notably at the first public reading of the Declaration of Independence.

- **Independence Hall:** 520 Chestnut Street, www.nps.gov/inde/index.htm

This red-brick Georgian-style building is where the Declaration of Independence and the Constitution were debated, drafted and signed by

(continued on page 40)



IN THE NEW ERA OF MANAGED CARE,
WHAT'S YOUR PLAN
TO WIN:

- More Patients
- More Profits
- More Time
- All of the Above

Go To **VisionSourcePlan.com** and
We'll Give You Ours



(continued from page 38)

America's forefathers.

• **Philadelphia Museum of Art:**

26th Street and Benjamin Franklin Pkwy, www.philamuseum.org

This world-class art museum was made famous by Matisse, Van Gogh, Picasso—and Rocky Balboa. Run up the famous stairs and pump your fists in triumph, then go inside to check out the masterpieces.

• **Rittenhouse Square:** 18th and Walnut streets

This popular neighborhood features top-notch restaurants, high-end stores and hip nightlife venues.

• **Reading Terminal Market:** 12th and Arch Streets, www.readingterminalmarket.org

This market, located beneath the Reading Railroad's 1891 train shed, hosts almost 100 different local food vendors.

• **Eastern State Penitentiary:** 2124 Fairmount Avenue, www.eastern-state.org

The oldest US prison still standing. Although it was shut down in the 1970s, visitors can tour the facility, including Al Capone's cell.

• **Please Touch Museum:** 4231 Avenue of the Republic, www.pleasetouchmuseum.org

Travel to Wonderland with Alice, practice your reading skills in the Story Castle and hone your science skills in the lab at this popular hands-on museum.

• **Masonic Temple:** 1 North Broad Street, <http://pagrandlodge.org/home.html>

The stone temple, one of the largest of its kind, was once the meeting place of one of history's more legendary organizations.



• **Philadelphia Zoo:** 3400 West Girard Avenue, www.philadelphiazoo.org

The Philadelphia Zoo is the oldest zoo in the country and today is the home to almost 2,000 animals.

• **Franklin Institute Science Museum:** 222 North 20th Street, www2.fi.edu

During your visit, check out the Sports Challenge, which explains the science behind sports such as surfing and rock climbing with the help of simulators. If space is more your thing, check out the Fels Planetarium.

Go Beyond Cheesteaks

If you're ravenous after a full day of CE during the AOA's annual meeting, your options for great food are plentiful. Take a pass on the cheesesteaks and dine in style at one of these top

10 Philadelphia eateries recommended by Yelp:

• **Amada:** 217 Chestnut Street, philadelphia.amadarestaurant.com

• **Vetri:** 1312 Spruce Street, www.vetriristorante.com

• **Zahav:** 237 St. James Place, www.zahavrestaurant.com

• **Bibou:** 1009 S. 8th Street, www.biboubyob.com

• **Morimoto:** 723 Chestnut Street, www.morimotorestaurant.com

• **Vernick Food & Drink:** 2031 Walnut Street, www.vernickphilly.com

• **Buddakan:** 325 Chestnut Street, www.buddakan.com

• **Modo Mio:** 161 W. Girard Avenue, www.modomiorestaurant.com

• **Barbuzzo:** 110 S. 13th Street, www.barbuzzo.com/barbuzzo

• **Alma De Cuba:** 1623 Walnut Street, www.almadecubarestaurant.com/

(continued from page 37)

Jun. 25-29, Philadelphia 2014 Optometry's Meeting

HOST: American Optometric Assn.
KEY FACULTY: More than 75 highly-respected optometric speakers
CE HOURS: 180 total/26 maximum for ODs

LOCATION: Pennsylvania Convention Center, 1101 Arch Street

CONTACT: Frances Ghannam
FGhannam@aoa.org

314-983-4214

www.optometrymeeting.org

AL AM BV CM CL CD CS CT DB DE EL GL
NO NT IN DS PE PH PM RE RS SD UV VT

Jun. 27-28, Omaha 3rd Annual American Conference on Pediatric Cortical Visual Impairment

HOST: Children's Hospital & Med. Ctr.
KEY FACULTY: Curtis Baxstrom, Mark Borchert, Jayna Fischbach, Linda Lawrence, Richard Legge, Sharon Lehman, Dominick Maino, Joseph Maino
CE HOURS: 12.7

LOCATION: Marriott Regency, 10220 Regency Circle

CONTACT: Sara Olsen
solsen@childrensomaha.org

(402) 955-6070

www.childrensomaha.org/upcoming-conferences

NO PE

Jun. 29-Jul. 6, Bahamas Tropical CE Bahamas

KEY FACULTY: Ben Gaddie, Diana Shechtman

LOCATION: Atlantis Resort

CONTACT: josh@tropicalce.com
www.tropicalce.com

Jun. 29-Jul. 9, Alaska Inside Passage Cruise Seminar

HOST: AEA Cruises

CE HOURS: 10

LOCATION: Grand Princess

CONTACT: Marge McGrath

aeacruises@aol.com

773-594-9866; 888-638-6009

www.optometriccruiseseminars.com

1-DAY ACUVUE® MOIST® Brand Contact Lenses: **EASIER TO REMOVE.** **NOT A DAILY HASSLE.**

4.3x

as many patients who tried
Dailies Total1® in a clinical study agreed
the lens **“felt stuck to my eye”***

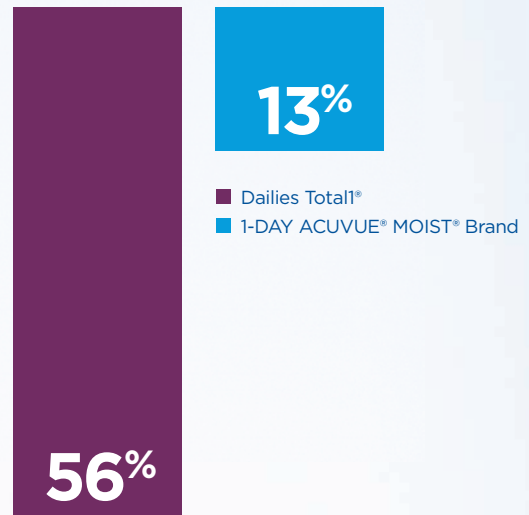

With contact lens wearers dropping out due to insertion/
removal issues,[†] **prescribe 1-DAY ACUVUE® MOIST® Brand**—
the lens that significantly more wearers said was
“easy to remove” than those wearing Dailies Total1®.*

Visit acuvuepro.com to learn more about
1-DAY ACUVUE® MOIST® Brand Family.



*In a clinical comparison with a double-masked, bilateral, crossover design (n=183).

[†]According to a multi-sponsor Gallup Study of the Consumer Contact Lens Market. (31% of former contact lens wearers said they stopped wearing lenses due to insertion/removal issues.)

ACUVUE® Brand Contact Lenses are indicated for vision correction. As with any contact lens, eye problems, including corneal ulcers, can develop. Some wearers may experience mild irritation, itching or discomfort. Lenses should not be prescribed if patients have any eye infection, or experience eye discomfort, excessive tearing, vision changes, redness or other eye problems. Consult the package insert for complete information. Complete information is also available from VISTAKON® Division of Johnson & Johnson Vision Care, Inc., by calling 1-800-843-2020 or by visiting acuvueprofessional.com.

The third-party trademarks used herein are trademarks of their respective owners.

ACUVUE®, 1-DAY ACUVUE® MOIST®, LACREON®, and VISTAKON® are trademarks of Johnson & Johnson Vision Care, Inc.

© Johnson & Johnson Vision Care, Inc. 2013 ACU-327121 December 2013

July

Sunday	Monday	Tuesday	Wednesday	Thursday	Friday	Saturday
		1	2	3	4	5
• Tropical CE Bahamas						
• Alaska Inside Passage Cruise Seminar						
				• Seine River Cruise Seminar		• Splendid China 2014
6	7	8	9	10	11	12
• Tropical CE Bahamas						
• Alaska Inside Passage Cruise Seminar				• Seine River Cruise Seminar		
• Splendid China 2014						
• Scandinavia/Russia Cruise Seminar						
				• Colorado Vision Summit		
				• Nova TPA Certification Course		
13	14	15	16	17	18	19
• Splendid China 2014						
• Scandinavia/Russia Cruise Seminar						
• Colorado Vision Summit				• New Technologies and Treatments in Vision Care 2014		
• Nova TPA Certification Course						
• Indiana University Summer CE	• A Summer in Germany - CE Abroad			• Indiana Optometry Summer Seminar	• 2014 Victoria Conference	
				• VT/Strabismus & Amblyopia		
20	21	22	23	24	25	26
• New Technologies and Treatments in Vision Care			• 2014 Florida Optometric Association Annual Convention			
• 2014 Victoria Conference			• CE in the Rockies			
• VT/Strabismus & Amblyopia			• Northern Rockies Optometric Conference			
					• Sacramento Valley Opt. Soc. Tahoe Summit	
27	28	29	30	31		
• 2014 Florida Optometric Assn. Annual Convention				• VT/Visual Dysfunctions		
• CE in the Rockies				• Strategies for Change: Diagnose, Adapt, Implement		
• Sacramento Valley Opt. Soc. Tahoe Summit						

Jul. 3-10, Paris/Normandy Seine River Cruise Seminar

HOST: AEA Cruises
KEY FACULTY: Peter Kehoe
CE HOURS: 10
LOCATION: AmaWaterways Amalegro
CONTACT: Marge McGrath
aeacruises@aol.com
773-594-9866; 888-638-6009
www.optometriccruiseseminars.com

Jul. 5-18, China Splendid China 2014

HOST: iTravelCE

KEY FACULTY: Joseph Pizzimenti,
Mile Brujic
CE HOURS: 24
LOCATION: Hong Kong, Guilin,
Chengdu, Tibet
CONTACT: Bridgitte Shen Lee
info@iTravelCE.com
832-390-1393 www.iTravelCE.com
AL CM CL CD CS CT NT IN DS PH PM RE
RS SD

Jul. 6-17, Scandinavia/Russia Scandinavia/Russia Cruise Seminar

HOST: AEA Cruises

CE HOURS: 10
LOCATION: Royal Princess
CONTACT: Marge McGrath
aeacruises@aol.com
773-594-0000; 888-638-6009
www.optometriccruiseseminars.com

Jul. 10-13, Steamboat Springs, CO Colorado Vision Summit

HOST: Colorado Opt. Assn. and Mtn.
States Congress of Optometry
KEY FACULTY: Andrew Gurwood,
Marc Myers, Marc Boomenstein, Leo
Semmes, Cathy Stern, W.C. Maples, Kyle

Cheatham, Mile Brujic, Steve Devick
 CE HOURS: 52 offered/20 obtainable
 LOCATION: Steamboat Grand Hotel
 and Resort, 2300 Mt. Werner Circle
 CONTACT: CVSummit@visioncare.org
 303-863-9778 or 1-877-691-2095
www.coloradovisionssummit.org

BV CL CD CT DB EL GL NO IN PE PH RE
RS SD UV VT

**Jul. 10-19, Fort Lauderdale
 Therapeutic Pharmaceutical Agents
 Certification Course**

HOST: Nova Southeastern University
 KEY FACULTY: Bruce Onofrey, Kim
 Reed, Joseph Sowka
 CE HOURS: 100
 LOCATION: Nova Southeastern
 University, 3200 S. University Drive
 CONTACT: Vanessa McDonald
oceaa@nova.edu
 954-262-4224
<http://optometry.nova.edu/ce/index.html>

CD DB GL NO IN PH

**Jul. 13, Bloomington, IN
 Summer CE Seminar**

HOST: Indiana University
 CE HOURS: 6
 LOCATION: Indiana University School
 of Optometry, 800 E. Atwater
 CONTACT: Cheryl Oldfield
coldfiel@indiana.edu
 812-856-3502
www.opt.indiana.edu/ce/Seminars.htm

**Jul. 14-17, Heidelberg, Germany
 A Summer in Germany—CE Abroad**

HOST: Rosenberg School of Optom-
 etry, University of the Incarnate Word
 KEY FACULTY: Marc Bloomenstein,
 Tim Wingert, Sandra Fortenberry
 CE HOURS: 20
 LOCATION, European Study Center,
 University of the Incarnate Word,
 Bergstrasse 106
 CONTACT: Sandra Fortenberry
rsoce@uiwtx.edu
 210-283-6856
www.optometry.uiw.edu/continuing

AL CD DE EL IN RE

**Jul. 16, Carmel, IN
 Indiana Optometry Summer Seminar**

HOST: Indiana Optometric Association
 KEY FACULTY: Joseph Sowka,
 Gregory Caldwell, Bradley Sutton
 CE HOURS: 7
 LOCATION: Ritz Charles,
 12156 N. Meridian St.
 CONTACT: Bridget Sims



Late-breaking Additions

Organizers of several meetings in 2014 will be finalizing specifics as their event date nears. Be sure to check back on the following events from the University of Houston College of Optometry (<http://ce.opt.uh.edu>) for further details as they become available.

• **CE in Forth Worth:** Scheduled for the fall. This meeting will take place at Alcon Laboratories, 6201 South Freeway, Fort Worth, TX, and will offer 16 CE credits. Exhibits included.

• **CE in Houston:** Date TBA. Attendees will be able to earn up to 16 CE credits at the meeting, which will be located at the UHCO-HBSC, 4901 Calhoun Road, Houston, TX. Exhibits included.

• **Everything Retina Symposium:** Scheduled for November 2014 at the Westin Riverwalk Hotel, 420 W. Market Street, San Antonio, TX. Sixteen CE credits will be available. Exhibits included.

• **Optometry Board Certification Examination Review Courses:** Scheduled for spring and fall of 2014 and hosted by KMK Education Services in cooperation with the University of Houston. The meeting

will take place at UHCO-HBSC, 4901 Calhoun Road, Houston, TX. Exhibits included.

• **West-Texas Two Step:** Scheduled for spring 2014 at the Embassy Suites, 5215 S. Loop 289, Lubbock, TX. The meeting will offer 16 hours of CE and exhibits will be included.

• **What's New at the U?:** Scheduled for fall 2014 at UHCO-HBSC, 4901 Cahoun Road, Houston, TX. Sixteen CE credit hours available and exhibits will be included.



blsims@ioa.org
 315-237-3560
www.ioa.org
GL NO IN PH SD

**Jul. 17-20, Minneapolis
 New Technologies and Treatments in
 Vision Care**

HOST: Review of Optometry
 KEY FACULTY: Paul Karpecki, Joseph Shovlin, Robert Wooldridge
 CE HOURS: 14
 LOCATION: Hilton Minneapolis,
 1001 Marquette Ave.
 CONTACT: Lois DiDomenico
ReviewMeetings@Jobson.com
 866-658-1772
AL CD DE EL GL NT IN PH SD

**Jul. 17-20, Victoria, BC
 2014 Victoria Conference**

HOST: Pacific University
 KEY FACULTY: Mark Andre, Nate Lighthizer, Cathy Evans
 CE HOURS: 20
 LOCATION: Hotel Grand Pacific,
 463 Belleville St.
 CONTACT: Jeanne Oliver
jeanne@pacificu.edu
 503-352-2740
www.pacificu.edu/optometry/ce/conferences_events.cfm
CL DE GL PH SD

**Jul. 17-21, Grand Rapids, MI
 VT/Strabismus & Amblyopia**

HOST: Opt. Extension Program Fndt.

KEY FACULTY: Robert A. Hohendorf
 CE HOURS: 28
 LOCATION: Vision and Sensory Center, 4467 Byron Center Road SW, Building 3
 CONTACT: Karen Ruder
Karen.Ruder@verizon.net
 410-561-3791
www.oepf.org
 AM BV

**Jul. 24-27, Boca Raton
 2014 FOA Annual Convention**

HOST: Florida Optometric Association
 CE HOURS: 30
 LOCATION: Boca Raton Resort & Club, 501 East Camino Real
 CONTACT: Joshua Hood
joshua@floridaeyes.org
 850-877-4697
www.floridaeyes.org
 PM

**Jul. 24-27, Estes Park, CO
 CE in the Rockies**

HOST: University of Houston College of Optometry
 CE HOURS: 16
 LOCATION: Rocky Mountain Park Inn,

101 South Saint Vrain Ave.
 CONTACT: Amanda Johnson
ajohnson@optometry.uh.edu
 713-743-1900
<http://ce.opt.uh.edu>

**Jul. 24-26, Jackson, WY
 Northern Rockies
 Optometric Conference**

HOST: Northern Rockies Optometric Conference
 CE HOURS: 16
 LOCATION: Snow King Hotel, 400 E. Snow King Ave.
 CONTACT: Kari Cline
director@nrocmeeting.com
 307-640-6157
www.nrocmeeting.com

**Jul. 25-27, Incline Village, NV
 Tahoe Summit**

HOST: Sacramento Valley Optometric Society
 CE HOURS: 12
 LOCATION: Hyatt Regency, 111 Country Club Drive
 CONTACT: Jerry Sue Hooper
jerrysue13@comcast.net
 (916) 446-2331

**Jul. 30-Aug. 3, Phoenix
 VT/Visual Dysfunctions**

HOST: Opt. Extension Program Fndt.
 KEY FACULTY: Robin D. Lewis
 CE HOURS: 35
 LOCATION: Office of Rob Lewis, 2950 N. Dobson, Suite 111
 CONTACT: Karen Ruder
Karen.Ruder@verizon.net
 410-561-3791
www.oepf.org
 BV

**Jul. 31-Aug. 2, San Diego
 2014 International Vision Conference
 Strategies for Change: Diagnose,
 Adapt, Implement**

HOST: OD Excellence
 KEY FACULTY: John McGreal, John Lahr, Jim Grue, Jerry Sude, Mark Wright
 CE HOURS: 18
 LOCATION: Manchester Grand Hyatt, 1 Market Place
 CONTACT: Johanna Lieblein
johanna@odexcellence.com
 707-433-5542
www.odexcellence.com
 AM BV CL DB DE EL GL NO DS PH PM RE
 SD



- Heart of America
2/14 - 2/15
- Texas Optometric
2/21 - 2/22
- SECO
3/13 - 3/15
- Int'l Visions Expo East
3/28 - 3/30
- ASCRS/ASOA
4/26 - 4/29
- Optometry's Meeting
6/26 - 6/28
- Colorado Vision Summit
7/12
- Vision Expo West
9/18 - 9/20
- GWCO Congress
10/10 - 10/11
- East West Eye Conference
10/9 - 10/11
- AA Ophthalmology
10/18 - 10/21
- COA Monterey Symposium
11/7 - 11/8
- AA Optometry
11/12 - 11/14

**FASHION
 Optical
 DISPLAYS**
 NATIONWIDE

FREE DISPENSARY DESIGN • MANUFACTURING • INSTALLATION
 800-824-4106 • WWW.FASHIONOPTICAL.COM

Invest In Your Practice And Get A Guaranteed Positive Return.

Lombart's CS-4 Package Offers Quality, Style & Value.



Ask about
optional Slit Lamp
& Chart Projector
configurations.

\$13,595

Or lease for \$269/mo.
for 60 months *

Package includes:

- The Lombart CS-4 Chair & Stand
- Topcon VT-10 Refractor
- Topcon SL-2G Slit Lamp
- Reichert LongLife Chart Projector with mount, slide & screen
- Upgrade to the Lombart CVSi21 for only \$2000 more or to the CVS-PC for only \$1500 more — Additional upgrades & configurations available.



(1-800-566-2278)

Call 1-800-Lombart

Or Your Local Lombart Representative.

Corporate Office - 5358 Robin Hood Road, Norfolk, VA 23513-2430
757-853-8888 | FAX 757-855-1232 | 800-566-2278 | 800-446-8092
www.lombartinstrument.com

ATLANTA•BALTIMORE/WASHINGTON D.C.•BOSTON•BOYNTON BEACH/MIAMI•BRADENTON•CHARLOTTE
CHICAGO•CINCINNATI•DALLAS•DENVER•DETROIT•GREENSBORO•HOUSTON•KANSAS CITY•KNOXVILLE•LOS ANGELES
MILWAUKEE•MINNEAPOLIS•NEW JERSEY/NEW YORK•NORFOLK•PORTLAND•SACRAMENTO•SAN DIEGO•SAN FRANCISCO

*Lease rate subject to credit approval, 1st payment is paid for by leasing company at signing with 59 remaining rental payments of \$269 and a \$1.00 purchase option. Taxes, freight and installation additional. Hand Instruments optional. Quantities limited. Subject to change without notice.

August

Sunday	Monday	Tuesday	Wednesday	Thursday	Friday	Saturday
					1 <div style="background-color: #0056b3; color: white; padding: 2px;">• SW Florida Optometric Assn. South Seas Educational Retreat</div> <div style="background-color: #8ebf4d; color: white; padding: 2px;">• Nova Smoky Mountain Summer</div>	2
3 <div style="background-color: #0056b3; color: white; padding: 2px;">• SW Fla. Optometric Assn. South Seas Educational Retreat</div> <div style="background-color: #8ebf4d; color: white; padding: 2px;">• Nova Smoky Mountain Summer</div>	4	5	6	7	8	9 <div style="background-color: #8ebf4d; color: white; padding: 2px;">• Ind. Univ. Grand Rounds Weekend</div>
10 <div style="background-color: #8ebf4d; color: white; padding: 2px;">• Ind. Univ. Grand Rounds Weekend</div>	11	12	13	14	15	16 <div style="background-color: #e69d00; color: white; padding: 2px;">• Mediterranean Cruise CE Seminar</div>
17	18	19	20	21	22	23
• Mediterranean Cruise CE Seminar						
24	25	26	27	28	29	30
31						

Aug. 1-3, Captiva Island, FL

South Seas Educational Retreat 2014

HOST: Southwest Florida Optometric Association

KEY FACULTY: Ben Gaddie, Carlo Pelino, April Jasper, Ron Foreman

CE HOURS: 18

LOCATION: South Seas Island Resort, 5400 Plantation Road

CONTACT: Brad Madaugh

swfoa@att.net

239-481-7799

www.swfoa.com

AL CD IN PH PM

Aug. 1-3, Asheville, NC

Smoky Mountain Summer

HOST: Nova Southeastern University

KEY FACULTY: Diana Shechtman,

Bill Jones

CE HOURS: 14

LOCATION: Grove Park Inn,

290 Macon Avenue

CONTACT: Vanessa McDonald

oceaaa@nova.edu

954-262-4224

<http://optometry.nova.edu/ce/index.html>

NT IN PE

Aug. 9-10, Bloomington, IN

Grand Rounds Weekend

HOST: Indiana University

CE HOURS: 12

LOCATION: Indiana University School of Optometry, 800 E. Atwater

CONTACT: Cheryl Oldfield

coldfiel@indiana.edu

812-856-3502

www.opt.indiana.edu/ce/Seminars.htm

Aug. 16-23, Italy, Croatia, Turkey & Greek Islands

Mediterranean Cruise CE Seminar

HOST: Academy of Ophthalmic Educ.

KEY FACULTY: Scot Morris

CE HOURS: 14

LOCATION: Royal Caribbean's

Splendour of the Seas

CONTACT: Claudia Marks

cmarks@aoece.com

905-731-6022

www.aoece.com

CL GL IN DS PH PM RE SD

1-DAY ACUVUE® MOIST® Brand Contact Lenses for ASTIGMATISM
and ACUVUE® OASYS® Brand Contact Lenses for ASTIGMATISM:

VISUAL STABILITY...

• 0.00Δ
• 0.01Δ

1-DAY ACUVUE® MOIST®
Brand for ASTIGMATISM*
ACUVUE® OASYS®
Brand for ASTIGMATISM*

ACUVUE® BRAND CONTACT LENSES
WITH BLINK STABILIZED™ DESIGN
HAS NO PRISM

WITHOUT THE VISUAL DISTURBANCE†

When a vertical prism dissociation of 0.5Δ or more
is present, it can lead to binocular disturbances in
contact lens patients with monocular astigmatism.†

• 0.52Δ Air Optix® Toric*
• 0.77Δ Biofinity® Toric*
• 1.15Δ PureVision® Toric*

BALLASTED
LENS DESIGN
HAS PRISM

Provide clear and stable vision all day.

*Δ=Prism diopter. Numbers represent the mean vertical prism.

†Potential binocular disturbances caused by induced vertical optic prism dissociation is a relevant factor for practitioners to consider when fitting toric contact lenses for monocular astigmats or those requiring a mix of toric soft contact lens designs. Clinical studies have not been done to fully characterize the clinical effects of differences in base-down prism among different contact lenses.

Contact lenses and lens prism are for illustration purposes only.

ACUVUE® Brand Contact Lenses are indicated for vision correction. As with any contact lens, eye problems, including corneal ulcers, can develop. Some wearers may experience mild irritation, itching or discomfort. Lenses should not be prescribed if patients have any eye infection, or experience eye discomfort, excessive tearing, vision changes, redness or other eye problems. Consult the package insert for complete information. Complete information is also available from VISTAKON® Division of Johnson & Johnson Vision Care, Inc., by calling 1-800-843-2020 or by visiting acuvueprofessional.com.

The third-party trademarks used herein are trademarks of their respective owners.

ACUVUE®, 1-DAY ACUVUE® MOIST®, ACUVUE® OASYS®, LACREON®, HYDRACLEAR®, BLINK STABILIZED™, INNOVATION FOR HEALTHY VISION™, and VISTAKON® are trademarks of Johnson & Johnson Vision Care, Inc.

© Johnson & Johnson Vision Care, Inc. 2014 ACU-325501 November 2013



FOR ASTIGMATISM

ACUVUE®
BRAND CONTACT LENSES

INNOVATION FOR HEALTHY VISION™

September

Sunday	Monday	Tuesday	Wednesday	Thursday	Friday	Saturday	
	1	2	3	4	5	6	
7	8	9	10	11	12	13	
	• Tropical CE Sonoma				• New Technologies and Treatments in Vision Care	• Vermont Opt. Assn. Fall CE	• Nova Diabetic Mgmt. Update & Annual Glaucoma Mtg.
14	15	16	17	18	19	20	
• New Technologies and Treatments in Vision Care • Vermont Opt. Assn. Fall CE • Nova Diabetic Mgmt. Update & Annual Glaucoma Mtg.			• Envision Conference 2014 • Vision Expo West		• Illinois Optometric Association Annual Conference	• NM Opt. Assn. Mid-Year Convention • Kentucky Opt. Assn. 2014 Fall Congress	
21	22	23	24	25	26	27	
• Kentucky Opt. Assn. 2014 Fall Congress • Central PA Opt. Soc. Annual CE Forum	• CE in Italy - Rome			• CE in Italy - Florence • Idaho Opt. Phys. Annual Congress 2014 • Wisconsin Opt. Assn. Convention & Annual Meeting	• Nebraska Opt. Assn. Fall Convention	• Univ. of Houston CE in Austin	
28	29	30					
• Wisconsin Opt. Assn. Convention & Annual Meeting • Nebraska Opt. Assn. Fall Convention • Univ. of Houston CE in Austin • PSS EyeCare Forum on Optometry	• CE in Italy - Tuscany						

Sept. 7-11, Sonoma, CA

Tropical CE Sonoma

KEY FACULTY: Paul Karpecki, Maynard Pohl
LOCATION: Hyatt Vineyard Creek
CONTACT: josh@tropicalce.com
www.tropicalce.com

Sept. 12-14, Tysons Corner, VA

(Washington, DC area)

New Technologies and Treatments in Vision Care

HOST: Review of Optometry
KEY FACULTY: Paul Karpecki, Derek Cunningham, Al Kabat, Mark Dunbar
CE HOURS: 15
LOCATION: Sheraton Premiere, 8661 Leesburg Pike
CONTACT: Lois DiDomenico
reviewmeetings@jobson.com
866-658-1772

AL CD DE EL GL NT IN PH SD

Sept. 12-14, Jay, VT

Vermont Optometric Association Fall CE Conference

HOST: Vermont Optometric Assn.
CE HOURS: 17
LOCATION: Jay Peak Resort, 830 Jay Peak Rd.
CONTACT: Suzanne Corbitt
vt.od.ce@gmail.com
www.vtoptometrists.org

(continued on page 52)



Vision Expo West: 350 Hours of CE

It's not just about frames. The twin Vision Expo conferences have emerged as major contenders in the CE meeting arena in recent years.

Case in point: Vision Expo West, which will be held from Sept. 17-20 at the Sands Expo & Convention Center in Las Vegas, will offer attendees 350-plus hours of continuing education developed by a conference advisory board representing some of the most renowned leaders in the profession. And many of the courses developed for 2014 will offer myriad opportunities for team learning that will engage and empower your entire optometric staff.

"The Vision Expo meetings are the only meetings where all members of the eye-care team sit side-by-side and learn together," says optometrist Kirk Smick, VEW chair.

In addition to team learning, VEW will also offer a special 14-hour glaucoma track that will highlight the most current thinking in the disease's diagnosis and treatment. "Technology and pharmaceuticals have changed dramatically over the last five years, and recognized experts from optometry and ophthalmology will bring us up to date," Dr. Smick says.

Spectacle lens design technology



is changing at a rapid pace. With that in mind, Vision Expo has created a "Lens Specialist Track" that will provide both the optometrist and optician with the latest on lens designs and coatings so they will have an easier time prescribing the best lens possible for the patient.

In government affairs, the alphabet soup of acronyms and new mandatory regulations are often hard to decipher, let alone to navigate. Vision Expo will help cut through the red tape with a new "Government Regulations" track, featuring courses on electronic health records, "meaning-

ful use," pediatric care in the Affordable Care Act, and other sessions that will help guide your practice through the often complicated maze of new government regulations.

Your practice's business needs and your patients' expectations are evolving. Discover how you can keep up, with the "CXO" track, which will show you how the position of Chief Experience Officer has become a major player in the business world—and health care is no exception. "Make someone in your office directly responsible for this most important task," Dr. Smick advises.

Also on the practice management end, the members of your staff responsible for purchasing frames need to make the best buying decisions possible. The "Frame Buyers Track" is a must for these team members, who will get the latest tips and resources to help boost this important part of your practice's bottom line.

Finally, many optometrists have added nutraceuticals to their patient care efforts. However, the AREDS2 study has left many questions about ocular vitamins unanswered. VEW will offer several courses to help you learn what nutraceuticals to recommend to your patients based on the most recent scientific data.

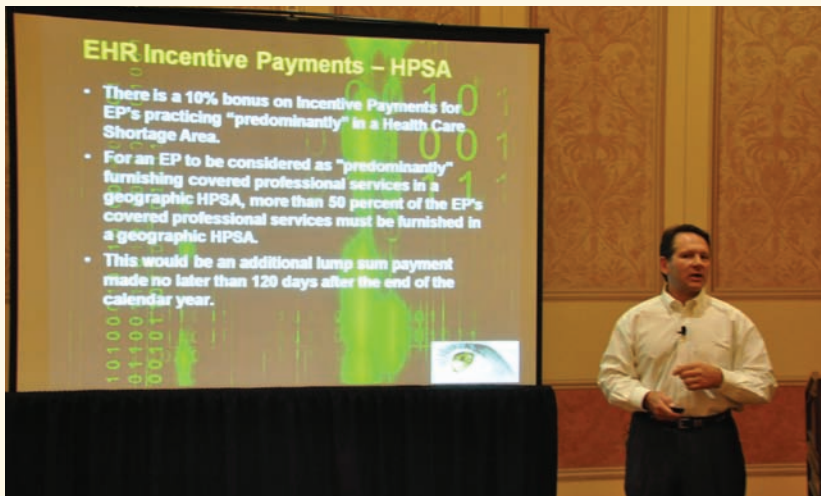



For more information about Vision Expo West or to register, go to www.visionexpowest.com.

Sightseeing Options

Las Vegas is renowned—some would say infamous—for its casinos and gambling. But the desert oasis offers much more than just one-armed bandits for nightly entertainment. From a gondola ride at the Venetian to a panoramic view of the city atop the Eiffel Tower at Paris, the glitz and glam of Sin City offers diversions to entice you away from the tables.

While at VEW, be sure to visit these Las Vegas originals:

- **The Mob Museum:** 300 Stewart Avenue, <http://themobmuseum.org>

Located in the heart of downtown Las Vegas, the Mob Museum showcases both sides of the notorious battle between organized crime and law enforcement.

- **Caesars Palace:** 3570 S. Las Vegas Blvd. www.caesarspalace.com.

A visit to this legend is what “doing Vegas” is all about.

- **Fountains of Bellagio:** 3600 Las Vegas Blvd., www.bellagio.com/attractions/fountains-of-bellagio.aspx

More than a thousand fountains at the Bellagio dance to music ranging from Pavarotti to Sinatra. Enjoy the show—for free!

- **O, by Cirque du Soleil:** O Theatre, 3600 S. Las Vegas Blvd., www.cirquedusoleil.com/en/shows/o/default.aspx

An ethereal, visually stunning show that incorporates the elements of air, fire and—most prominently—water.

- **Stratosphere Tower Thrill Rides:** 2000 Las Vegas Blvd., www.stratospherehotel.com/Tower/Rides.

All rides are at the top of the Stratosphere Tower, over 900 feet high.

- **Shark Reef Aquarium, Mandalay Bay:** 3950 S. Las Vegas Blvd., www.sharkreef.com

A trip to the Shark Reef at Manda-

lay Bay takes guests on a 14-exhibit journey through a jungle environment into a sunken shipwreck where they will see 2,000 animals, including some of the most dangerous predators in the world.

Beyond the Buffet

Leave the all-you-can-eat buffets to the tourists and you’ll find that Las Vegas is a foodie’s delight, with celebrity chef venues and some of the country’s best steakhouses. Here are the top 10 Las Vegas eateries, according to Yelp:

1. **Lotus of Siam:** 953 E. Sahara Avenue, www.saipinchutima.com
2. **Joël Robuchon:** 3799 S. Las Vegas Blvd., www.joel-robuchon.net
3. **Picasso:** Bellagio Hotel, 3600 Las Vegas Blvd. S, www.bellagio.com
4. **L’Atelier de Joël Robuchon:** 3799 South Las Vegas Blvd., www.mgmgrand.com/restaurants/atelier-joel-robuchon-french-restaurant.aspx
5. **Eiffel Tower Restaurant:** 3655 Las Vegas Blvd. S, www.eiffeltower-restaurant.com
6. **Tom Colicchio’s Craftsteak:** 3799 Las Vegas Blvd. S, www.craftrestaurantsinc.com/craftsteak-las-vegas
7. **Gordon Ramsay Steak:** 3655 Las Vegas Blvd. S, www.parislasvegas.com/restaurants/gordon-ramsay-steak.html#UpuLJ449Xdk
8. **Sage:** 3732 Las Vegas Blvd. S, www.ariaslasvegas.com/dining/restaurants/sage
9. **Mon Ami Gabi:** 3655 Las Vegas Blvd. S, www.monamigabi.com/home/?loc=vegas
10. **Bouchon:** 3355 Las Vegas Blvd. S, bouchonbistro.com/lasvegas

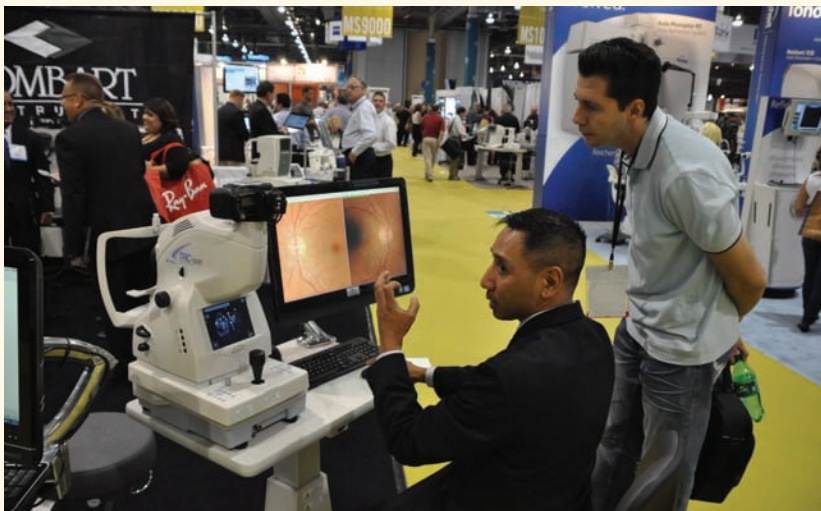



Go Further—Without Leaving Home



Expand your clinical skills and catch up on your CE requirements, all from the comfort of your own home.

Review offers **nearly 100 hours** of COPE-approved continuing education — right now! It's **just a click away**. Our extensive library of exams runs the gamut from keratoconus to fundus autofluorescence, and everything in between.



www.revoptom.com/continuing_education

Download a QR scanner app. Launch app and hold your mobile device over the code to view www.revoptom.com/continuing_education.

REVIEW[®]
OF OPTOMETRY

(continued from page 48)

**Sept. 13-14, Fort Lauderdale
Diabetic Management Update and
Annual Glaucoma Meeting**

HOST: Nova Southeastern University
KEY FACULTY: Joseph Sowka

CE HOURS: 12

LOCATION: Nova Southeastern
University, 3200 S. University Drive

CONTACT: Vanessa McDonald

oceaa@nova.edu 954-262-4224

<http://optometry.nova.edu/ce/index.html>

DB GL

**Sept. 17-20, Minneapolis
Envision Conference 2014**

HOST: Envision University

CE HOURS: 23

LOCATION: Hyatt Regency Minneapo-
lis, 1300 Nicollet Mall

CONTACT: Michael Epp

michael.epp@envisionus.com

316-440-1515

www.envisionconference.org

BV CM CL CD DB GL NO NT DS PE PM SD

**Sept. 17-20, Las Vegas
Vision Expo West**

HOST: Int'l Vision Expo & Conference

CE HOURS: 350 total

LOCATION: Sands Expo & Convention
Center, 201 Sands Ave.

www.visionexpowest.com

AL AM BV CM CL CD CS CT DB DE EL GL

NO NT IN DS PE PH PM RE RS SD UV VT

**Sept. 18, Springfield, IL
IOA Annual Conference**

HOST: Illinois Optometric Association
CE HOURS: 15

LOCATION: Crowne Plaza Hotel

CONTACT: Charlene Marsh

ioabb@ioaweb.org

217-525-8012

www.ioaweb.org

**Sept. 19-20, Mesalero, NM
New Mexico Optometric Association
Mid-Year Convention**

HOST: New Mexico Optometric Assn.
CE HOURS: 8

LOCATION: Inn of the Mountain Gods,
287 Carrizo Canyon Rd.

CONTACT: Richard Montoya

newmexicooptometry@gmail.com

575-751-7242

www.newmexicooptometry.org

**Sept. 19-21, Covington, KY
KOA 2014 Fall Congress**

HOST: Kentucky Optometric Assn.

CE HOURS: 20

LOCATION: Marriott RiverCenter
Hotel, 10 West Rivercenter Blvd.

CONTACT: Sarah Unger

sarah@kyeyes.org 502-875-3516

www.kyeyes.org

**Sept. 21, Hershey, PA
CPOS Annual CE Forum**

HOST: Central PA Optometric Society

CE HOURS: 6

LOCATION: The Hotel Hershey,
100 Hotel Rd.

CONTACT: Mary Good

cposrsvp@gmail.com

**Sept. 21-23, Rome, Italy
CE in Italy**

HOST: James L. Fanelli

KEY FACULTY: Leonard Messner,
Lorraine Lombardi, James Fanelli

CE HOURS: 12

CONTACT: James Fanelli

jamesfanelli@CEinItaly.com

910-452-7225

www.CEinItaly.com

CM CD GL NO RE SD

**Sept. 25-27, Florence, Italy
CE in Italy**

HOST: James L. Fanelli

KEY FACULTY: Leonard Messner,
Lorraine Lombardi, James Fanelli,
Carlo Pelino

CE HOURS: 12

CONTACT: James Fanelli

jamesfanelli@CEinItaly.com

910-452-7225

www.CEinItaly.com

CD CT DB EL GL NO NT RE SD UV

**Sept. 25-27, Boise, ID
Idaho Optometric Physicians
Annual Congress 2014**

HOST: Idaho Optometric Physicians

CE HOURS: 19

LOCATION: Boise Centre, 850 West
Front St.

CONTACT: Randy L. Andregg

randregg7@frontier.com

(208) 461-0001

idaho.aoa.org

AL CL DB DE GL IN PH RE SD

**Sept. 25-28, Middleton, WI
Wisconsin Optometric Association
Convention and Annual Meeting**

HOST: Wisconsin Optometric Assn.

KEY FACULTY: Leo Semes, Jim
Thimons, Jordan Keith, Gregg Heatley

CE HOURS: 22

LOCATION: Marriott Madison West

CONTACT: Joleen Breunig

joleen@woa-eyes.org

608-824-2200

www.woa-eyes.org

GL NO NT PH RE

**Sept. 26-28, Kearney, NE
NOA Fall Convention**

HOST: Nebraska Optometric Assn.

CE HOURS: 10

LOCATION: Younes Conference
Center, 416 Talmadge St.

CONTACT: Alissa Johnson

noa@assocoffice.net

402-474-7716

nebraska.aoa.org/fallconvention

**Sept. 27-28, Austin
CE in Austin**

HOST: University of Houston College
of Optometry

CE HOURS: 16

LOCATION: Omni Austin Hotel
Downtown, 700 San Jacinto Blvd.

CONTACT: Amanda Johnson

ajohnson@optometry.uh.edu

713-743-1900

<http://ce.opt.uh.edu/>

**Sept. 28-29, Mystic, CT
Forum on Optometry**

HOST: PSS EyeCare

CE HOURS: 18

LOCATION: Marriott, 625 North Road

CONTACT: Sonia Kumari

education@psseyecare.com

203-415-3087

www.psseyecare.com

AL AM CM CL CD CS CT DB DE EL GL NT

IN PH PM RE RS SD UV

**Sept. 28-30, Tuscany, Italy
CE in Italy**

HOST: James L. Fanelli

KEY FACULTY: James Fanelli, Leonard
Messner, Carlo Pelino

CE HOURS: 12

CONTACT: James Fanelli

jamesfanelli@CEinItaly.com

910-452-7225

www.CEinItaly.com

CM DB EL GL NO PH RE SD UV

**Date TBA, Berkeley, CA
Annual Berkeley Optometry CE**

HOST: Berkeley Optometry

CE HOURS: 7

LOCATION: UC Berkeley

CONTACT: Sarah Segal

sarah_segal@berkeley.edu

510-642-2622

www.optometry.berkeley.edu

CAN'T WAIT UNTIL NEXT MONTH?

Optometric Physician delivers **UP-TO-DATE** news and research to your inbox every Monday morning, allowing you to view all of the latest clinical information on a convenient and consistent basis.

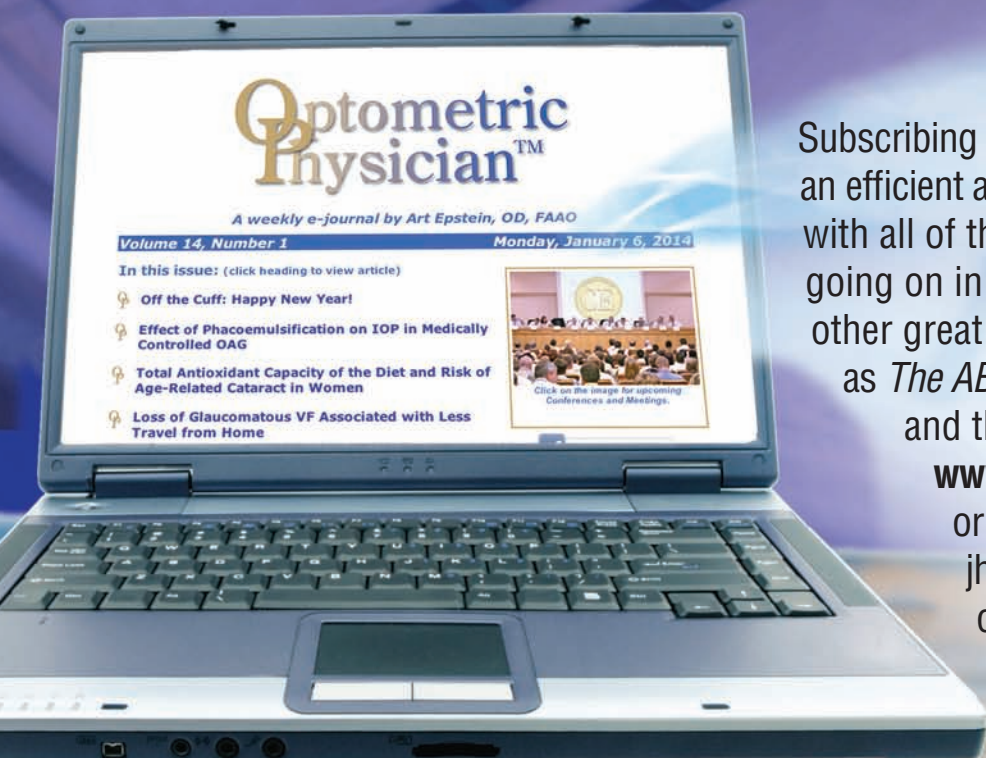

Subscribing to **Optometric Physician** is an efficient and easy way to stay current with all of the information and events going on in the field. To get this and other great *Review* e-newsletters such as *The ABCs of OCT*, *Retina Revealed*, and the *RCCL Newsletter*, go to www.jobson.com/globalemail or email Joe Morris (jmorris@jhihealth.com) to stay abreast of industry developments.

Optometric
Physician™

October

Sunday	Monday	Tuesday	Wednesday	Thursday	Friday	Saturday
			1 • Indiana Optometry Fall Seminar	2 • Okla. Assn. of Opt. Phys. Fall Conference • Missouri Opt. Assn. Annual Convention	3	4
5 • Missouri Opt. Assn. Annual Convention	6	7	8	9 • East West Eye Conference GWCO Congress 2014	10	11 • Forum on Ocular Disease
12 • East West Eye Conference • GWCO Congress 2014 • Forum on Ocular Disease	13	14 • Sacramento Valley Optometric Soc. General Meeting	15 • Michigan Opt. Assn. Annual Fall Seminar	16	17	18 • Nova Orlando Super Weekend • CE Seminar and Optifair Canada
19 • Nova Orlando Super Weekend • CE Seminar and Optifair Canada	20	21	22	23 • COVD Annual Meeting	24	25
26	27	28	29	30	31 • Fellowship of Christian Optometrists Conference	

Oct. 1, Bloomington, IN
Indiana Optometry Fall Seminar

HOST: Indiana Optometric Association
 KEY FACULTY: Jimmy Bartlett, Kimberly Reed, Paul Karpecki, Todd Peabody, Richard Meetz, Joseph Carroll, Stephen Burns
 CE HOURS: 14
 LOCATION: Indiana Memorial Union, 900 E. 7th Street
 CONTACT: Bridget Sims
blsims@ioa.org

317-237-3560
www.ioa.org
 GL NO NT IN PH SD

Oct. 2-4, Tulsa, OK
OAOP Fall Conference

HOST: Oklahoma Association of Optometric Physicians
 KEY FACULTY: Scot Morris, et al.
 CE HOURS: 18
 LOCATION: Renaissance Tulsa Hotel & Convention Center, 6808 South 107th East Avenue

CONTACT: Heatherlyn Burton
heatherlyn@oaop.org
 405-524-1075
www.oaop.org

Oct. 2-5, Springfield, MO
2014 Missouri Optometric Assn. Annual Convention

HOST: Missouri Optometric Assn.
 KEY FACULTY: Ben Gaddie, Kia Eldred, Sally Bodenhamer
 CE HOURS: 14
 LOCATION: University Plaza Hotel,

333 John Q Hammons Pkwy
 CONTACT: Sue Brown
sue@moeyecare.org
 573-635-6151
www.moeyecare.org
 DB GL NO

Oct. 9-12, Cleveland
EastWest Eye Conference

HOST: Ohio Optometric Association
 KEY FACULTY: Jerome Sherman, Grace Than, Carl Hillier, Gary Etting, Lynn Hellerstein, Melton & Thomas, Danica Marrelli, Murray Fingeret, Jim Thimons, Paul Ajamian, Andrew Gurwood, Marc Myers, Leo Semes, Jay Haynie, Leo Messne, Nick Coletrella, Jeff Varanelli, Brad Sutton, Al Kabat, Christine Sindt
 CE HOURS: 180 offered/25 attainable
 LOCATION: Cleveland Convention Center, 1 St. Clair Ave. NE
 CONTACT: Linda Fette
Linda@ooa.org
 614-781-0708
www.eastwesteye.org

AL AM BV CM CL CD CS CT DB DE EL GL
 NO NT IN DS PE PH PM RE RS SD UV VT

Oct. 9-12, Portland, OR
GWCO Congress 2014

HOST: Great Western Council of Optometry
 KEY FACULTY: Charles Brownlow, Ben Gaddie, Jimmy Jackson, David Kading, Robert Prouty, Eric Schmidt, Diana Shechtman, Nancy Torgerson
 CE HOURS: 70
 LOCATION: Oregon Convention Center, 777 NE Martin Luther King Jr. Blvd
 CONTACT: Tracy Oman
gwco@gwco.org
 503-654-1062
www.gwco.org

AL AM BV CM CL CD CS CT DB DE EL GL
 NO NT IN DS PE PH PM RE RS SD UV

Oct. 11-12, Orlando
Forum on Ocular Disease

HOST: PSS EyeCare
 KEY FACULTY: Ronald Melton, Randall Thomas, Paul Ajamian, Deepak Gupta
 CE HOURS: 18
 LOCATION: Swan and Dolphin Hotel, 1500 Epcot Resorts Blvd.
 Contact: Sonia Kumari
education@psseyecare.com
 203-415-3087



OCTOBER 9-12, PORTLAND, OR

GWCO Congress 2014

The Great Western Council of Optometry invites optometrists, allied ophthalmic professionals and optometry students to its 2014 Congress in Portland, OR. The meeting will be held from Oct. 9-12. This year's congress offers a strong line-up of speakers, including optometrists Charles Brownlow, Ben Gaddie, Nancy Torgerson and Eric Schmidt. The congress will include 90+ hours of CE, a Rocktometry Exhibit Hall of Fame, daily lunches and evening

events.

"We are pleased to offer new and exciting lecture topics for optometrists and their staff from some of the leading presenters around the nation," says GWCO President Sue E. Lowe, OD, FCOVD.

The meeting will also offer exhibits, events for students and residents and industry-sponsored seminars. For more information or to register, go to www.gwco.org.



OCTOBER 9-12, CLEVELAND

EastWest Eye Conference

The 17th annual EastWest Eye Conference will remain true to its commitment to provide world-class education to both doctors and staff by offering more than 250 hours of education during its 2014 meeting, scheduled from Oct. 9-12 in Cleveland. The conference will feature presentations by many optometric leaders, including Ron Melton and Randall Thomas, Paul Ajamian, Jerry Sherman, Gary Gerber, Ben Gaddie, Danica Marrelli, Murray Fingeret, Jim Thimons, Leo Semes, John McGreal, Al Kabat, Bruce Onofrey, Andy Gurwood, Marc Myers and many more.

The meeting location is Cleveland, Ohio's Global Center for Health Innovation and Cleveland Convention Center—a state-of-the-art facility designed specifically for medical education.

In addition to CE, the 2014 EastWest Eye Conference planners didn't forget about entertainment. The EastWest Eye Conference will once again take over a local landmark for the Friday Night Rock and Roll Hall of Fame Party.

For more information, or to register, go to http://www.eastwesteye.org/aws/OOA/pt/sp/home_east-westconf.

www.psseyecare.com

AL AM CM CL CD CS CT DB DE EL GL NT
 IN PH PM RE RS SD UV

Oct. 14, TBD, CA
Sacramento Valley Optometric Society General Meeting

HOST: Sacramento Valley Optometric Society

CE HOURS: 2

CONTACT: Jerry Sue Hooper
jerrysue13@comcast.net
 916-447-0270

Oct. 15-16, Lansing, MI
Michigan Optometric Association 46th Annual Fall Seminar

HOST: Michigan Optometric Assn.



Unique As A Fingerprint

HUMAN EYE IS UNIQUE AS A FINGERPRINT AND REQUIRES A CUSTOM CORRECTIVE SOLUTION. FOR THIS REASON, WE NEED FAST, VERSATILE AND ACCURATE METHODOLOGIES FOR EYE EXAMINATION ACCORDING TO EACH INDIVIDUAL PATIENT'S UNIQUE VISION CORRECTION NEEDS.

WAVEFRONT REFRACTION TECHNOLOGY

IN THE NEW HRK-8000A AUTO REF/KERATOMETER IS THE ANSWER FOR MEASURING A HUMAN EYE WITH ULTRA-PRECISION



Huvitz

**COBURN
TECHNOLOGIES**

**NEW PARTNERS IN DIAGNOSTIC INNOVATION
CALL FOR DETAILS AND SPECIAL OFFERS**

1-800-COBURN-1 (800-262-8761)
www.coburntechnologies.com

CE HOURS: 14

LOCATION: Lansing Center, 333 E. Michigan Ave.

CONTACT: Amy Root

amy@themoa.org

517-482-0616

www.themoa.org

Oct. 18-19, Orlando

Orlando Super Weekend

HOST: Nova Southeastern University

KEY FACULTY: Michael Chaglasian, Joseph Sowka

CE HOURS: 12

LOCATION: Nova Southeastern University,

4850 Millenia Blvd.

CONTACT: Vanessa McDonald

oceaa@nova.edu

954-262-4224

<http://optometry.nova.edu/ce/index.html>

GL

Oct. 18-19, Brampton, Ontario

Continuing Education Seminar and Optifair Canada Trade Show

HOST: Academy of Ophthalmic Education

CE HOURS: 14

LOCATION: Embassy Grand Convention Centre,

8800 The Gore Road

CONTACT: Claudia Marks

cmarks@aoecea.com

905-731-6022

www.aoecea.com

CT DB DE NT IN PH RE SD

Oct. 21-25, San Diego

COVD 44th Annual Meeting

HOST: College of Optometrists in

Vision Development

LOCATION: Sheraton San Diego Hotel & Marina,

1380 Harbor Drive

CONTACT: Jackie Cencer

jcencer@covd.org

330-995-0718

www.covd.org

AM BV NO NT PE PM

Oct. 31-Nov. 2, Nashville, IN

25th Annual Educational Conference

HOST: Fellowship of Christian Optometrists Int'l

KEY FACULTY: Kyle Cheatham et al.

CE HOURS: 12

LOCATION: Abe Martin Lodge, Brown County

State Park

CONTACT: Mike Goen

foreknown@aol.com

850-530-9626

www.fcoint.net

CL CD RE

CONTINUE YOUR EDUCATION WITH REVIEW

OUR FLAGSHIP TITLE, *REVIEW OF OPTOMETRY*, IS THE MARKET'S LEADING RESOURCE FOR ALL OF YOUR OPTOMETRY NEEDS.

Review of Optometry is your primary source for ground-breaking clinical information as well as timely news, market trend information and continuing education programs.

Review of Cornea & Contact Lenses serves as a valuable resource for all practitioners and features detailed articles focusing on various fitting methods, solutions and corneal cases. Also available is the *Review of Cornea & Contact Lenses "Annual Contact Lenses & Lens Care" Guide*, a yearly publication detailing the newest lenses and lens care products.

The *Review* Group's *Ophthalmic Product Guide* brings you the newest and most innovative products on the market. Published every February and July, the guide provides concise information about new literature, drugs and equipment designed to help your practice thrive.

The *Review* Group also offers valuable **Continuing Education** sessions in both print and online formats, allowing a convenient way for you to earn **CE credits**. In addition, *Review* also offers an impressive fleet of **free e-newsletters**, such as *Optometric Physician*, the *Optometric Retina Society* quarterly e-newsletter and the *Optometric Glaucoma Society E-Journal* so you can keep up to date on breaking news and the latest research online.



The Review Group is dedicated to the constant growth and education of the profession. Review offers many different publications and services to help enhance your practice and patient care.



On top of these products, the *Review* Group also spearheads meetings and conferences, bringing together experts in the field and providing a forum for practitioners to earn CE credits and learn from others in the profession.

www.revoptom.com



Jobson Medical Information LLC
Review Professional Publications Group

November

Sunday	Monday	Tuesday	Wednesday	Thursday	Friday	Saturday
						1 • Optometric Assn. of Louisiana
2	3	4	5	6 • Calif. Optometric Association Monterey Symposium 2014 • Art & Science of Optometric Care - A Behavioral Perspective • VT/Visual Dysfunctions • VT/Learning Related Visual Problems	7 • Wisconsin Optometric Association Primary Care Symposium	8
9 • Calif. Optometric Assn. Monterey Symposium 2014 • Art & Science of Optometric Care - A Behavioral Perspective • VT/Visual Dysfunctions • VT/Learning Related Visual Problems	10 • AFOS/Academy 2014	11 • ONS Fall 2014 Educ. Symposium • OGS Annual Scientific Meeting • OCRT Symposium	12	13 Academy 2014 Denver • NCSOS Fall Congress	14	15
16	17	18 • Sacramento Valley Opt. Soc. General Meeting	19	20	21	22
23	24	25	26	27	28	29
30						

**Nov. 1, Lafayette, LA
Fall Conference**

HOST: Optometry Assn. of Louisiana
CE HOURS: 8
LOCATION: Hilton Hotel & Towers
CONTACT: Jim Sanderfur
optla@bellsouth.net
318-335-0675

www.optla.org

CD DB DE EL GL PH SD

**Nov. 6-9, Monterey, CA
Monterey Symposium 2014**

HOST: California Optometric Assn.
KEY FACULTY: Melissa Barnett, Jay Binkowitz, Michael Chaglasian, Dickon

Chan, A. Paul Chous, George Comer
CE HOURS: 40+
LOCATION: Monterey Marriott Hotel,
350 Calle Principal
CONTACT: Rachael Van Cleave
contact@coavision.org

(continued on page 62)

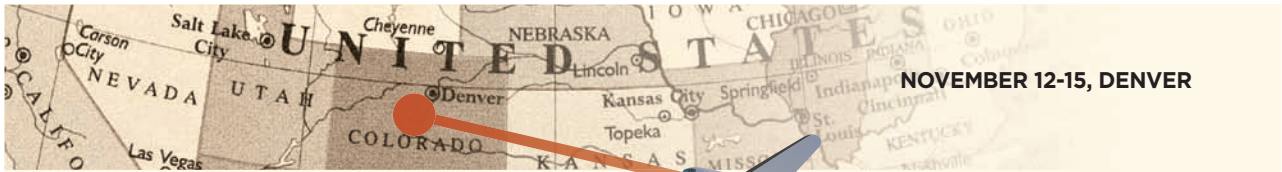

Academy 2014 Elevates the Profession

The mile-high city will host the American Academy of Optometry's annual meeting, a much-anticipated event featuring some of the brightest and most innovative leaders in the field, who will shine a light on where the future of optometry is heading.

AAO's 2014 meeting, to be held from Nov. 12-15 at the Colorado Convention Center in Denver, will allow attendees to earn 35 hours of CE credit.

"The Academy strives to deliver an energetic annual meeting that brings together practitioners, residents, students and others to interface with optometry's foremost educators, vision researchers, and clinical specialists in our profession," says optometrist Brett Bence, FFAO, president-elect of the AAO board of directors. "We serve as a very large forum for exchange of knowledge. We hold a commitment to provide our members and profession a platform for dissemination of the latest ophthalmic research that impacts patient care."

Always a stand-out at the Academy meetings, the Monroe J. Hirsch Research Symposium for 2014 will be



"Mechanisms of Presbyopia Correction—Beyond Benjamin Franklin," where speakers conducting basic, optical and clinical research will discuss advances in understanding the underlying mechanism and cutting-edge treatments for presbyopia. Presenters include Stephen D. McLeod, MD, Paul L. Kaufman, MD, and Susana Marcos, PhD.

The 'Ezell Fellows Present' series, another favorite feature of the Acad-

emy meeting, will focus on low vision, with presentations by Robert Massof, PhD, FFAO, Susana Chung, OD, PhD, FFAO, and Bradley Dougherty, OD, PhD, FFAO.

"Why do we need another photoreceptor? Clinical implications of melanopsin-containing retinal ganglion cells" is the topic for the ARVO/AAO Joint Symposium where attendees will hear first-hand the latest research that will provide evidence that "intrinsically photosensitive retinal ganglion cells" (ipRGCs) play a role in mediating the effect of light on learning, memory, metabolic function, proper retina development and photophobia. Speakers include Ignacio Provencio, PhD, David Copenhagen, PhD, Paul Gamlin, PhD, and Andrew Hartwick, OD, PhD, FFAO.

For 2014, the AAO is considering an expansion of the "hot topics" sessions, where fresh, peer-reviewed progressive research that has immediate clinical application is highlighted, Dr. Bence says.

As technology evolves, the latest innovations will also be a key point of discussion at the 2014 meeting.

(continued on page 60)



(continued from page 59)

"We continue to marvel at the innovative technologies from our industry partners that enable us to make more accurate diagnosis and treatment decisions," Dr. Bence says. "Every year, the Academy emphasizes the scientific and clinical basis of this new information as we advance our profession."

For more information, or to register, go to www.aaopt.org.

Ancillary Meetings

Several specialty organizations hold their own annual meetings during or prior to the Academy. Mark your calendars for the following:

Optometric Council on Refractive Technology (pictured below): The OCRT's 11th Annual Refractive Technology symposium will be held the day before Academy 2014 Denver. The brightest minds in cornea and lens-based refractive technologies will discuss the latest innovations and trends in refractive correction. The meeting is interactive, providing a unique forum to share ideas, thoughts and experiences with colleagues.

Attendees can expect to learn the up to date information about refractive technology and surgery, including laser vision correction,

intraocular lenses, laser-assisted cataract surgery, keratoconus surgical options, plus other advanced and investigative vision correction procedures and devices, says Chris Freeman, OD, president of OCRT. "The dynamic format and top-notch, renowned speakers make it memorable and rewarding to hear from many optometric leaders in anterior segment, all in one day," he says.

Eight hours of COPE-approved CE will be awarded to attendees. The high caliber of the day's educational content and faculty, with meals included and eight CE hours earned for a very low price of \$200, also makes it one of the most valuable as well as one of the best educational experiences, Dr. Freeman says.

For more information go to www.ocrt.org or contact Dr. David Geffen at dig2020@aol.com.

Ocular Nutrition Society: Join the ONS as it explores recent studies and delves into the many benefits of nutraceuticals that support the prevention and control of ocular and systemic disease during the ONS's 2014 Educational Symposium, which will be held on Nov. 11. Six hours of COPE-approved CE credit will be awarded for attendees. For more information, go to www.ocularnutritionociety.org, or contact Dr. Jeffrey Anshel at ocularnutritionociety@gmail.com.

Armed Forces Optometric Society:

The AFOS meeting will be held on Nov. 10 at the Denver Marriott City Center & Colorado Convention Center and will offer six hours of COPE-approved CE credit. Topics that will be covered include corneal/conjunctival disease, diabetes, glaucoma, neuro-ophthalmic disorders, pharmacology, retinal disorders, refractive surgery, systemic disease and uveitis. For more information, go to www.afos2020.org or contact Gina Borgognoni at execdir@afos2020.org.

Optometric Glaucoma Society:

The OGS will hold its annual scientific meeting on Nov. 11. The meeting is invitation only and offers eight hours of CE credit. Contact Michael Chaglasian, OD, at MChaglas@ico.edu. For more information, go to: www.optometricglaucomasociety.org/.

Tourist Attractions

Whether you get to town a day early or can only spare a few hours between CE courses, Denver offers a wealth of attractions. Be sure to include these must-sees on your itinerary:

• **Denver Art Museum:** 100 W. 14th Ave. Parkway, www.denverartmuseum.org. Boasts one of the world's greatest collections of Western American art.

• **16th Street Mall:** <http://16thstreetmalldenver.com>.

The one-mile-long 16th Street Mall is home to a diverse collection of more than 500 retailers, restaurants and bars.

• **Denver U.S. Mint:** 320 West Colfax Avenue, www.usmint.gov/mint_tours/?action=startreservation. See how money is made!

• **Denver Zoo:** 2300 Steele Street, www.denverzoo.org

Home to 3,500 different animals, representing more than 650 species.

• **Denver Performing Arts Complex:** 1245 Champa Street, <http://artscomplex.com>

Hosts Broadway blockbusters, Tony Award-winning theatre, ballet, opera and symphony.

• **Denver Botanic Gardens:** 1007 York Street, www.botanicgardens.org

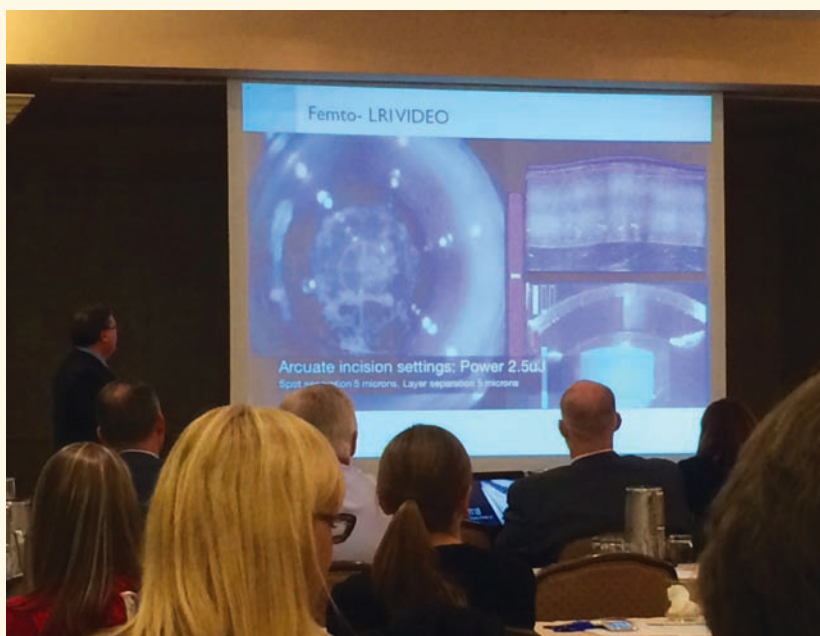

(continued on page 62)

Left your *Review of Optometry* magazine at the office? No problem!



Get *Review* sent to your desktop or mobile device!

Just simply go to www.revoptom.com and click on the digimag link to get your current issue.

(continued from page 58)

916-441-3990

www.coavision.org/i4a/pages/index.cfm?pageid=3288

CS DB DE GL NT DS PE PH PM RS SD

**Nov. 6-10, Pomona, CA
VT/Visual Dysfunctions**

HOST: Optometric Extension Program Foundation

KEY FACULTY: John Abbondanza

CE HOURS: 35

LOCATION: Western University of Health Sciences College of Optometry, 309 E. Second St.

CONTACT: Karen Ruder
Karen.Ruder@verizon.net

410-561-3791

www.oepf.org

BV

**Nov. 6-10, Grand Rapids, MI
The Art & Science of Optometric
Care – A Behavioral Perspective**

HOST: Optometric Extension Program Foundation

KEY FACULTY: Rober A. Hohendorf

CE HOURS: 35

LOCATION: Vision and Sensory Center, 4467 Byron Center Roads SW, Building 3

CONTACT: Karen Ruder
Karen.Ruder@verizon.net

410-561-3791

www.oepf.org

BV PE

**Nov. 6-10, Memphis
VT/Learning Related Visual Problems**

HOST: Optometric Extension Program Foundation

KEY FACULTY: Paul A. Harris

CE HOURS: 35

LOCATION: Southern College of Optometry, 1245 Madison Ave.

CONTACT: Karen Ruder
Karen.Ruder@verizon.net

410-561-3791

www.oepf.org

BV VT

**Nov. 7-8, Green Bay, WI
Optometric Association Primary Care
Symposium**

HOST: Wisconsin Optometric Assn.

KEY FACULTY: Joe Pizzimenti, Carlo Pelino

CE HOURS: 9

LOCATION: Hyatt on Main

CONTACT: Joleen Breunig
joleen@woa-eyes.org

(continued from page 60)

The Boettcher Memorial Tropical Conservatory is the largest single-structure tropical conservatory in the US.

• **Downtown Aquarium:** 700 Water Street, <http://www.aquariumrestaurants.com/downtownaquariumdenver>

The largest aquarium west of Chicago and east of California.

Fine Dining in Denver

Downtown Denver is known for its restaurants, ranging from funky French to ultra-healthy vegan to farm-to-table hotspots that pair up local cuisine with hometown microbrews. Here are Denver's top 10 restaurants courtesy of Yelp:

• **Rioja:** 1431 Larimer Street, www.riojadenver.com

• **Lotus Vegetarian Restaurant:** 1015 S. Federal Blvd., (no website)

• **Root Down:** 1600 W 33rd Avenue, www.rootdowndenver.com

• **Z Cuisine Bistrot:** 2239 W 30th Avenue, <http://zuisineonline.com>

• **Mizuna:** 225 E 7th Avenue, <http://mizunadenver.com>

• **Fruition Restaurant:** 1313 E 6th Avenue, <http://fruitionrestaurant.com>

• **Pho 95:** 1401 S Federal Blvd., www.pho95noodlehouse.com

• **TAG:** 1441 Larimer Street, www.tag-restaurant.com

• **Restaurant Kevin Taylor:** 1106 14th Street, www.restaurantkevintaylor.com

• **Ocean Prime:** 1465 Larimer Street, www.oceanprimedenver.com



608-824-2200

www.woa-eyes.org

GL NO PH RE

**Nov. 10-15, Denver
AFOS/Academy 2014**

HOST: Armed Forces Optometric Society & AAO

KEY FACULTY: Leading-edge optometric educators

CE HOURS: 45

LOCATION: Denver Marriott City Center & Colorado Convention Center, 1701 California St.

CONTACT: Gina Borgognoni
execdir@afos2020.org

214-533-0227

www.afos2020.org

CD DB GL NO PH RE RS SD UV

**Nov. 11, Denver
OCRT Annual Symposium**

HOST: Optometric Council on Refractive Technology and Review of Optometry

CE HOURS: 8

CONTACT: David Geffen

dig2020@aol.com

www.ocrt.org

CM CS CT RS

(continued on page 64)



THE RICK BAY FOUNDATION

for Excellence in Eyecare Education

www.rickbayfoundation.org

Support the Education of Future Healthcare & Eyecare Professionals



About Rick

Rick Bay served as the publisher of *The Review* Group since 1991.

To those who worked for him, he was a leader whose essence was based in a fierce and boundless loyalty.



To those in the industry and the professions he served, he will be remembered for his unique array of skills and for his dedication to exceeding the expectations of his customers, making many of them fast friends.

Scholarships will be awarded to advance the education of students in both **Optometry** and **Ophthalmology**, and will be chosen by their school based on qualities that embody Rick's commitment to the profession, including integrity, compassion, partnership and dedication to the greater good.

Interested in being a partner with us?

Visit www.rickbayfoundation.org

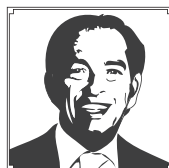

THE RICK BAY FOUNDATION
for Excellence in Eyecare Education



Parasol®



A PERFECT FIT

ODYSSEY MEDICAL + BEAVER VISITEC

The Odyssey Parasol® Punctal Occluder is now part of Beaver-Visitec International (BVI), a world leader of trusted ophthalmic brands. Not only is the Parasol® a perfect fit for your dry eye patients, but combining BVI with the outstanding success of the Parasol®, continues the tradition of superior knowledge, products and services.

For those of you who depend on a quality product from Odyssey Medical, **WELCOME TO BVI.**

Your new ordering information:
866-906-8080
customersupport@beaver-visitec.com
www.odysseymed.com
www.beaver-visitec.com



Beaver-Visitec International, Inc. | 411 Waverley Oaks Road Waltham, MA 02452 USA | BVI, BVI Logo and all other trademarks (unless noted otherwise) are property of a Beaver-Visitec International ("BVI") company © 2014 BVI

(continued from page 62)

Nov. 11, Denver

Fall 2014 Educational Symposium

HOST: Ocular Nutrition Society & AAO

CE HOURS: 6

CONTACT: Jeffrey Anshel

ocularnutritionociety@gmail.com

800-383-1202

www.ocularnutritionociety.org

NT

Nov. 11, Denver

**Optometric Glaucoma Society
Annual Scientific Meeting**

HOST: OGS & AAO

CE HOURS: 8

CONTACT: Michael Chaglasian

MChaglas@ico.edu

www.optometricglaucomasociety.org

org

GL

Nov. 12-15, Denver

Academy 2014 Denver

HOST: American Academy of

Optometry

CE HOURS: 35

LOCATION: Colorado Convention

Center, 700 14th St.

CONTACT: Helen Viksnins

HelenV@aaoptom.org

321-710-3937

www.aaopt.org

AL AM BV CM CL CD CS CT DB DE EL GL

NO NT IN PE PH PM RE RS SD UV VT

Nov. 13-15, Asheville, NC

NCSOS Fall Congress

HOST: North Carolina State

Optometric Society

CE HOURS: 18

LOCATION: The Grove Park Inn,

290 Macon Ave.

CONTACT: Adrienne Drollette

adrienne@nceyes.org

252-237-6197

www.nceyes.org

Nov. 18, TBD, CA

**Sacramento Valley Optometric
Society General Meeting**

HOST: Sacramento Valley Optometric
Society

CE HOURS: 2

CONTACT: Jerry Sue Hooper

jerrysue13@comcast.net

916-447-0270

December

Sunday	Monday	Tuesday	Wednesday	Thursday	Friday	Saturday
	1	2	3	4	5	6
					<div style="background-color: #4b4b4b; color: white; padding: 2px;">• VT/Strabismus & Amblyopia</div> <div style="background-color: #0056b3; color: white; padding: 2px;">• Symposium on Contemporary Eye Care</div>	<div style="background-color: #e69d00; color: white; padding: 2px;">• Cornea, Contact Lens & Contemporary Vision Care Symposium</div>
7	8	9	10	11	12	13
<div style="background-color: #4b4b4b; color: white; padding: 2px;">• VT/Strabismus & Amblyopia</div> <div style="background-color: #0056b3; color: white; padding: 2px;">• Symposium on Contemporary Eye Care</div> <div style="background-color: #e69d00; color: white; padding: 2px;">• Cornea, Contact Lens & Contemporary Vision Care Symposium</div>						
14	15	16	17	18	19	20
21	22	23	24	25	26	27
28	29	30	31			

Dec. 4-7, Phoenix

VT/Strabismus & Amblyopia

HOST: Opt. Extension Program Fndtn.
 KEY FACULTY: Robin D. Lewis
 CE HOURS: 28
 LOCATION: Office of Rob Lewis,
 2950 N. Dobson, Suite 111
 CONTACT: Karen Ruder
Karen.Ruder@verizon.net
 410-561-3791;

www.oepf.org **AM BV**

Dec. 5-7, Orlando

Symposium on Contemporary Eye Care

HOST: Optometric Management
 LOCATION: Disney Yacht/Beach Clubs
 CONTACT: Maureen Platt; 215-628-7754
maureen.platt@pentavisionmedia.com
www.pentavisionevents.com

Dec. 6-7, Houston

31st Annual Cornea, Contact Lens & Contemporary Vision Care Symp.

HOST: Univ. of Houston Col. of Opt.
 CE HOURS: 16
 CONTACT: Amanda Johnson
ajohnson@optometry.uh.edu
 713-743-1900
<http://ce.opt.uh.edu/>
CL CD

Advertisers Index

Alcon Laboratories **68**
 Phone (800) 451-3937
 Fax (817) 551-4352

Allergan, Inc. **13**
 Phone (800) 347-4500

Bausch + Lomb **23**
 Phone (800) 323-0000
 Fax (813) 975-7762

Coburn Technologies **56**
 Phone (800) 262-8761
 www.coburntechnologies.com

CooperVision **67**
 Phone (800) 341-2020

Essilor of America **7**
 www.essilorusa.com

Fashion Optical Displays **44**
 Phone (800) 824-4106
 Fax (530) 877-2013

FCI Ophthalmics **29**
 Phone (800) 932-4202

HAI Laboratories **35**
 Phone (781) 862-9884
 Fax (781) 860-7722

Keeler Instruments **21**
 Phone (800) 523-5620
 Fax (610) 353-7814

Lombart Instruments **45**
 Phone (800) 446-8092
 Fax (757) 855-1232

NicOx, Inc. **8,9**
 Phone (214) 346-2913
 www.nicox.com

Odyssey Medical (now part of Beaver-Visitec International, Inc.) **64**
 Phone (866) 906-8080
 www.odysseymed.com

S4OPTIK **31**
 Phone (888) 224-6012

Vision Source **39**
 Phone (281) 312-1111
 Fax (281) 312-1153
 www.visionsource.com

Vistakon **2,3,17,41,47**
 Phone (800) 874-5278
 Fax (904) 443-1252

ZeaVision, LLC **25**
 Phone (866) 833-2800
 support@eyepromise.com
 www.eyepromise.com

This advertiser index is published as a convenience and not as part of the advertising contract. Every care will be taken to index correctly. No allowance will be made for errors due to spelling, incorrect page number, or failure to insert.



THE 2014 SECO SHOW DAILY!

The SECO conference, one of the premier educational events of the year, will take place March 12-16, 2014 — and *Review of Optometry* will be there! *Review's* on-site editorial staff will provide live daily coverage of important show news and events, educational highlights, product launches and more.

Attendees on-site can pick up the SECO Daily each morning for the latest news and highlights. Those at home can stay in touch, too—a digital edition of the SECO Daily will be posted online, plus an e-newsletter will be sent out each morning with the day's top stories.

Show copies will also be available at *Review of Optometry* booth #613.





Drifting
down the Nile
stretched out
on a silk pillow,
fanned by
the breeze
of a thousand
hummingbirds.

Impossibly comfortable.

Describing the comfort of CooperVision® Biofinity® contact lenses may take your patients to imaginary places, but the technology behind them is very real.

Aquaform® Technology gives Biofinity lenses a level of breathability and moisture content unmatched by any other monthly brand. And now with Biofinity XR, we are expanding the benefits to more patients.



Biofinity® XR contact lenses

Available +8.50D to +15.00D and -12.50D to -20.00D



CooperVision®
Live Brightly.®

SAME ADVANCED LENSES NEW ENHANCED LOOK



DAILIES® AquaComfort Plus® contact lenses come in a **new blue box**, but inside you'll find the same lasting comfort and material found in the market-leading daily disposable contact lens material¹

REFRESHING ALL-DAY COMFORT, FROM THE FIRST BLINK



MOISTURIZING AGENTS

Advanced moisturizing agents PVA, PEG and HPMC help deliver comfort from insertion to the end of the day.



BLINK-ACTIVATED MOISTURE

Moisture is released on both sides of the lens with every blink, helping to result in a stabilized tear film.

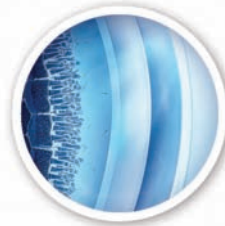

SUPERIOR TEAR FILM STABILITY^{2,3*}

Tear film stability helps support clear vision.

PERFORMANCE DRIVEN BY SCIENCE™



*Versus DAILIES® All Day Comfort, 1-DAY ACUVUE® MOIST® and SofLens® daily disposable contact lenses. ^Trademarks are the property of their respective owners.

References: 1. Based on third-party industry report, 12 months ending July 2013; based on unit sales, Alcon data on file. 2. Wolffsohn J, Hunt O, Chowdhury A. Objective clinical performances of 'comfort-enhanced' daily disposable soft contact lenses. *Cont Lens Ant Eye*. 2010;33(2):88-92. 3. Alcon data on file, 2010, 2013.

See product instructions for complete wear, care, and safety information.  only

© 2013 Novartis 10/13 DAL13371JAD

Alcon
a Novartis company